

Implementing architectural measures against external impact, such as intense solar radiation in summer and cold temperatures in winter, using building envelopes to control and maintain the indoor environment is a vital technology. We must value this technology in order to take advantage of the full potential of natural energy and equipment so that we can create a comfortable living environment.

# 4

## Chapter 4 : Heat Control Technology of Building Envelopes

# 4

## Chapter 4 Heat Control Technology of Building Envelopes (Elemental Technology Application Method 2)

### 4.1 Insulated Building Envelope Planning for Zone V

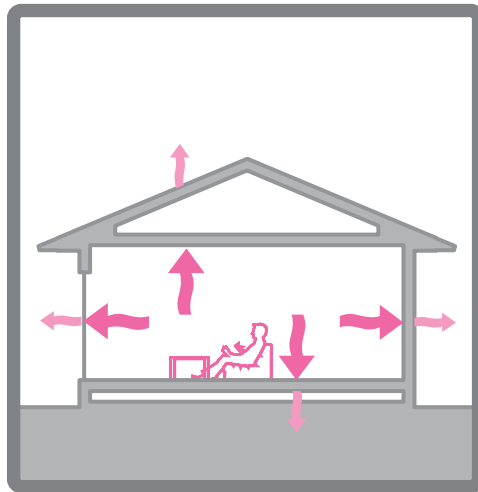

Traditionally, people in warm regions have lived in a house with a thick thatched insulated roof, earth walls with high heat and moisture capacity, open layout, and many windows, whereas people in cold regions have endured harsh winters in a timber frame house filled with sawdust. Even though the purposes are different, these ancient techniques make maximum use of indigenous materials and create a pleasant living environment.

Recently, building insulation has been in the limelight as one of the elemental technologies to achieve energy conservation and an even living environment. As such, this section introduces several insulation techniques that are suitable for diverse housing styles and maintain appropriate temperatures as needed, with focus on the 'accessible technology' aspect of insulation by explaining its original purposes as faithfully as possible.

#### 4.1.1 Purpose and Key Points of Insulated Building Envelope Planning

##### 1. Controlling amount of energy used for heating

- The purpose of insulated building envelope planning is to control heat transfer at the boundary between the interior and exterior of the house, i.e. the building envelope. Insulated houses can achieve a comfortable indoor thermal environment using much less energy than uninsulated houses.
- Fig. 1 is a comparison graph of each insulation level of the energy conservation standard (See p.128), i.e. the 1992 standard, the intermediate insulation level of the 1992 standard and the 1999 standard, 1999 standard, and the 1980 standard. The higher the insulation level, the lower the heating cost.

**Note**  
Energy consumption, costs and other data described in this section are based on simulation results of the model house plan (See Chapter 6).

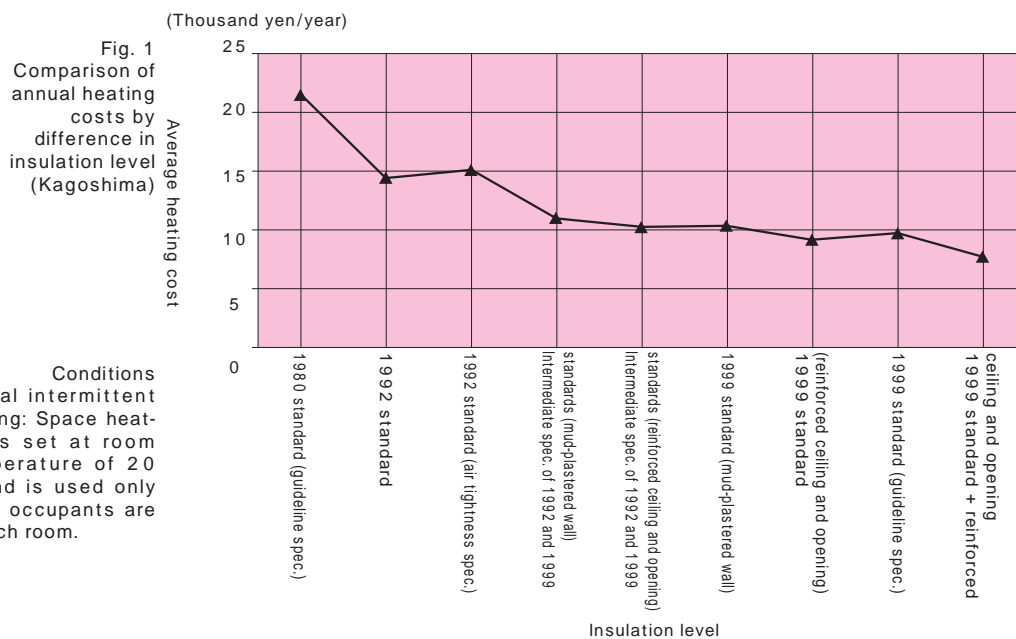

- In other words, heating of a larger area is possible with less cost and energy.
- Two types of energy are found in houses: energy obtained from solar radiation (solar heat gain) and energy generated from daily activities (internal heat generation). Fig. 2 represents the image of how insulation reduces heating energy and increases the proportion of the solar heat gain and internal heat generation energy contributing to heating.
- If the house is not insulated, solar heat gain and internal heat generation escapes within a short period of time, but with insulation this energy becomes effective in raising the room temperature.

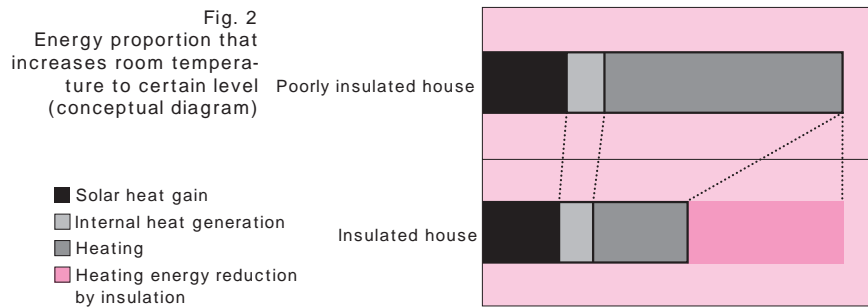

## 2. Maintaining natural room temperature

- Fig. 3 is a graph showing changes in the unheated room temperature (natural room temperature\*) by insulation specifications. As shown in the graph, the higher the insulation level, the greater the room temperature compared to the outside outdoor air temperature.
- Even in an unheated room, the room temperature increases due to the heat coming from heated rooms as well as the solar heat gain and internal heat generation. Insulation can maintain a higher room temperature.

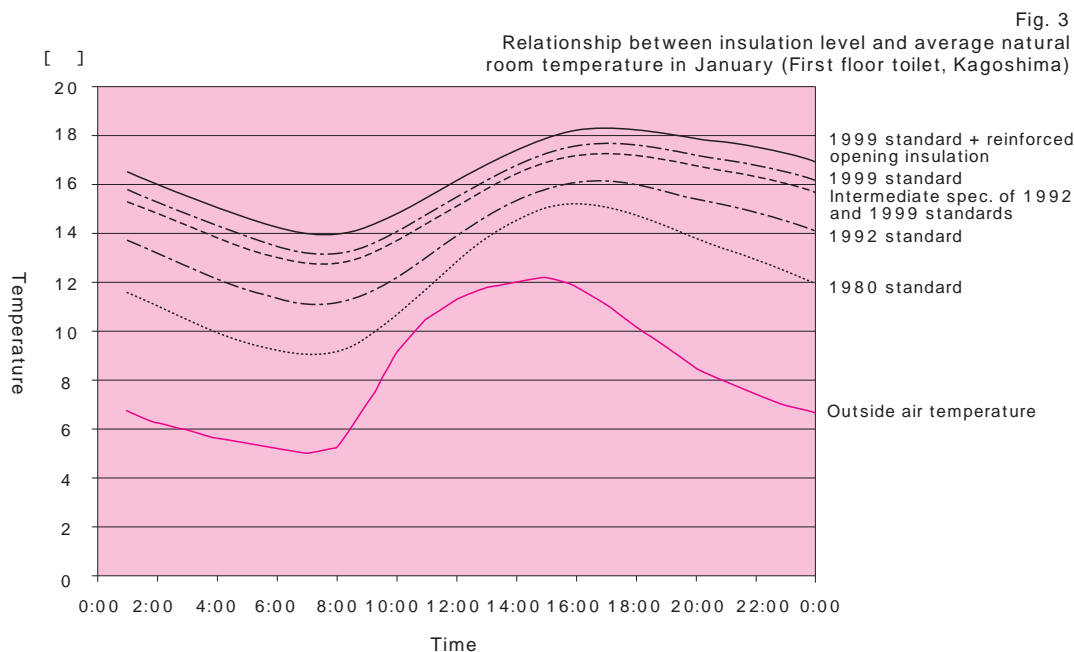

\* Natural room temperature: Room temperature obtained from solar heat gain and internal heat generation without heating and cooling system. Here, this refers to natural room temperature of unheated first floor toilet when partial intermittent heating is used only in habitable rooms.

# 4

### 3. Attempts to equalize surface temperature of walls, floors and windows with room temperature

- Many of you must have experienced when the room feels somewhat cold even though the room temperature is not low. This occurs when there is a significant gap between the room temperature (air temperature) and perceived temperature (thermal sensation).
- Generally, thermal sensation perceived in living space is an average of the surface temperature of surrounding windows, walls, floors and other elements (mean radiant temperature) and the room temperature, as shown below.

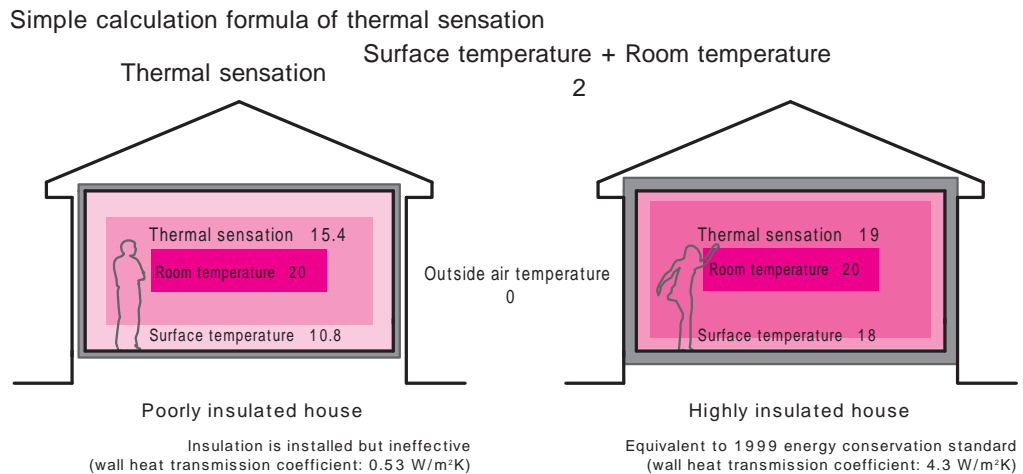

Fig. 4 Room temperature, surface temperature and thermal sensation

- Fig. 4 shows the difference in the room temperature and the thermal sensation between an uninsulated or hardly insulated house and a carefully insulated house. In the left diagram, the wall surface temperature is low and even when the room temperature is set at 20°C using space heating, thermal sensation is only 15.4°C. On the other hand, in the right diagram, since the house is well insulated, the surface temperature of building envelope is closer to room temperature, if the room temperature is set at 20°C in the same way as the left diagram, a thermal sensation of 19°C is felt.
- As described above, simply raising the air temperature does not achieve sufficient warmth within the home. It is necessary to attempt to equalize the surface temperature of walls and other surroundings to the room temperature and reduce the temperature difference between the thermal sensation and the room temperature by insulating the house.

### 4. Increasing temperature around the feet

- One of the causes of feeling cold is a chilly feeling around the feet. This is due to lack of insulation and air leakage (Fig. 5). Even when the room is heated, it is not comfortable if occupants feel warm around the upper area of the room but their feet are cold.
- Reinforcing the insulation performance of floors (i.e. installing insulation and air leakage prevention) increases the floor surface temperature and reduces the vertical temperature gradient and temperature irregularity within the house.

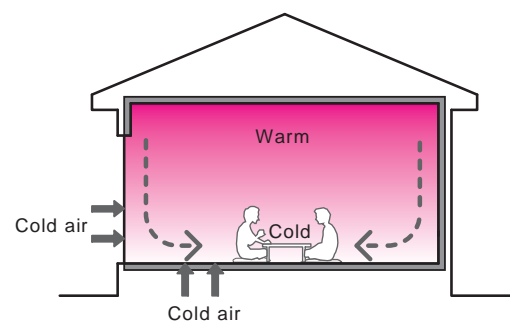
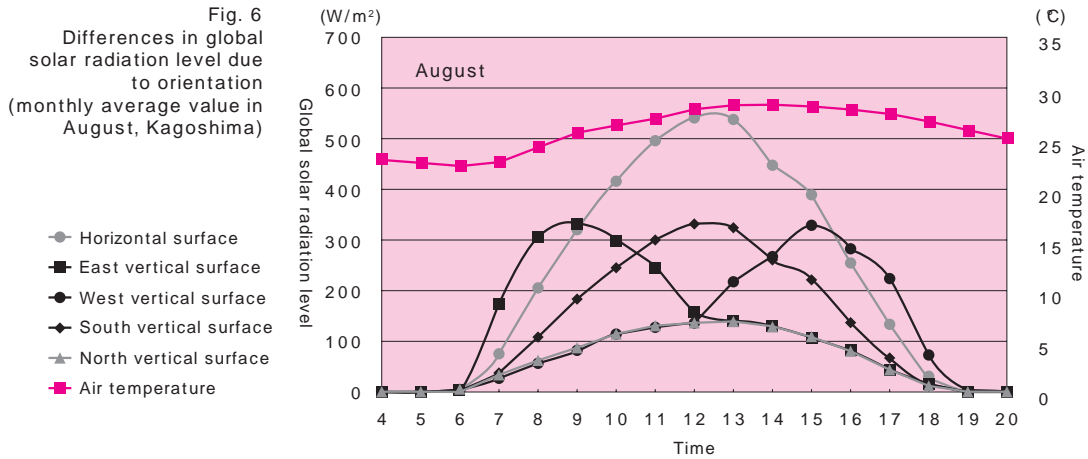

Fig. 5 Indoor vertical temperature gradient

## 5. Shading solar radiation heat from roof to reduce heat in upper floor rooms

- Horizontal surfaces receive a large amount of solar radiation heat in summer (Fig. 6). Thus, the roof temperature reaches 60 – 70°C in summer.
- Reinforcing roof and ceiling insulation prevents solar radiation heat received on the roof from entering the house and reduces the heat in the upper floor rooms.
- However, a ventilated cavity (at least approx. 30 mm) is required if the roof is insulated and an attic ventilation is required if the ceiling is insulated (See 4.3 Solar Shading Methods for Zone V for details).



### Comment Relationship between houses and external environment

Many of you might think houses have less of a relationship with the outside environment (wind, light, warmth and coolness) as their insulation level increases.

However, in fact, by skillfully combining the advanced insulation technology (e.g. openings with high insulation performance) with the cross ventilation and solar shading technology in the summer and in-between seasons, we can

maximize the “comfort” brought from nature into the house while ensuring a pleasant indoor environment using a heating and cooling system in winter and during severe summer months.

Insulation is a fundamental housing technology that increases the relationship between the house and the external environment and corresponds to diverse lifestyles.

# 4

## 4.1.2 Energy Conservation Target Levels for Insulated Building Envelope Planning

### 1. Definition of target levels

- Energy conservation target levels for insulated building envelope planning have been set at levels 1-4 below and indicate the reduction rate of energy consumed by heating systems.

Level 0	: Heating energy reduction rate	None
Level 1	: Heating energy reduction rate	Approx. 30% (Approx. 40%)
Level 2	: Heating energy reduction rate	Approx. 50% (Approx. 50%)
Level 3	: Heating energy reduction rate	Approx. 55% (Approx. 60%)
Level 4	: Heating energy reduction rate	Approx. 65% (Approx. 70%)

Energy reduction rates shown above indicate calculated values when partial intermittent heating is set at 20°C in major habitable rooms with occupants (values in parentheses are for when whole-building continuous heating is set at 18°C).

- Target levels are set by the heat loss coefficient<sup>1</sup> according to the current energy conservation standard<sup>2</sup>.
- The standard heating energy consumption as of 2000 was 5.0 GJ (approximately 7% of overall energy consumption) for partial intermittent heating and 13.4 GJ (approximately 13%) for whole-building continuous heating (See 6.1 on p.339).

#### 1 Heat loss coefficient

This refers to a numerical indicator of housing insulation performance and is generally known as Q value. The lower this value the higher the insulation performance. Heat loss coefficient is obtained by calculating the amount of heat (heat loss) that escapes from exterior walls, ceilings, floors and other components of the house as well as the heat loss due to ventilation and air leakage and dividing the result by the total floor area of the house. This is the amount of heat (joules) which escapes outside the house per unit of time (seconds) and 1m<sup>2</sup> of floor area when the indoor and outdoor temperature difference is 1°C.

#### 2 Energy conservation standards

Refers to the standard established according to the Law Regarding the Rationalization of Energy Use (Energy Conservation Law) enacted in 1979. Since its establishment in 1980, this standard has been amended and reinforced in 1992 and 1999. The 1980, 1992 and 1999 standards are sometimes referred to as the "Former Energy Conservation Standards", "New Energy Conservation Standards" and "Next Generation Energy Conservation Standards", respectively. These standards are almost equivalent to Grades 2, 3 and 4 of the energy saving grading based on the evaluation method standard of the Housing Performance Indication System.

### 2. How to achieve target levels

- Energy conservation target levels for insulated building envelope planning can be achieved by applying insulation methods that satisfy each value of heat loss coefficient (Table 1).
- Level 0 serves as reference level that is equal to or below the 1980 energy conservation standard. Level 2 refers to insulation performance equivalent to Region III of the 1992 energy conservation standard.
- Please use as reference Table 1 which shows the corresponding relationship between the target levels and the grades based on the energy saving grading (related to thermal environment) of the Housing Performance Indication System.

Table 1 Target Levels for Insulated Building Envelope Planning

Target level	Energy saving effect (heating energy reduction rate)		Heat loss coefficient	Corresponding energy conservation standard	Grade according to energy saving grading of Housing Performance Indication System
	Partial intermittent heating	Whole-building continuous heating			
Level 0	0	0	8.3 W/m <sup>2</sup> K or below	Insulation level equivalent to 1980 energy conservation standard, etc.	Grade 1 (not satisfying 1980 standard) or Grade 2 (equivalent to 1980 standard)
Level 1	Approx. 30%	Approx. 40%	4.6 W/m <sup>2</sup> K or below	Insulation level equivalent to 1992 energy conservation standard	Grade 3
Level 2	Approx. 50%	Approx. 50%	3.3 W/m <sup>2</sup> K or below	Insulation level equivalent to intermediate of 1992 and 1999 energy conservation standards	Grade 3
Level 3	Approx. 55%	Approx. 60%	2.7 W/m <sup>2</sup> K or below	Insulation level equivalent to 1999 energy conservation standard	Grade 4
Level 4	Approx. 65%	Approx. 70%	2.1 W/m <sup>2</sup> K or below	Insulation level exceeding 1999 energy conservation standard	Grade 4

### 3. Target housing construction methods

- This chapter covers the following two housing construction methods and explains the insulation technology that takes into account the characteristics of each construction method. It shows the example methods for achieving the target levels of insulated building envelope planning.
  - a. Average conventional timber frame house
  - b. Traditional conventional timber frame house (typical example: mud plastered wall)
- This chapter is targeted at houses in South Kyushu and other hot humid regions (Zone V of the zone classification of the energy conservation standard). There are various construction methods for conventional timber frame houses reflecting regional characteristics in Zone V.
- This chapter emphasizes the importance of examining insulation methods suitable for each housing construction method, rather than examining housing construction methods that focus on insulation. Therefore, we have chosen a mud plastered wall construction as a typical example of traditional conventional timber frame houses to explain insulation methods as well as a stud wall construction and other average conventional timber frame houses.

#### 4.1.3 Steps for Examining Insulated Building Envelope Planning and Setting Target Levels

##### 1. Steps for examining insulated building envelope planning

###### Step 1 Confirming lifestyle orientation and other conditions and setting target level

Confirm the lifestyle orientation of occupants, housing structure, construction cost and other conditions and examine and set the target insulation level suitable for those conditions.

- 1) Confirm lifestyle orientation
- 2) Confirm insulation construction budget
- 3) Confirm housing structure and form
  - Average conventional timber frame house
  - Traditional conventional timber frame house (mud plastered wall)

###### Step 2 Examining insulation plans

Examine the basic plans for insulated building envelope planning for houses.

- 1) Examine insulation methods (interior insulation, exterior insulation, combined insulation)
- 2) Examine insulation planning methods for each target level  
(distribution for building components: evenly distributed or partially reinforced insulation type)

###### Step 3 Examining insulation technology

Examine specific insulation technology and methods.

- 1) Examine insulation technology for building envelopes
  - Insulation material types and considerations for installation
  - Basic structure of thermal barrier
  - Airflow blocking installation
  - Insulation material installation
  - Examination of insulation methods for each component
- 2) Examine insulation technology for openings
  - Window selection
  - Sash selection
  - Reinforced insulation with interior and exterior coverings
  - Insulation effects by insulating shutters

# 4

\* Difference between outside air temperature and room temperature (natural room temperature)  
In this section, this refers to the difference between outside air temperature and room temperature (natural room temperature) when the outside air is the lowest during the hours of dawn.

## 2. Confirming lifestyle orientation and other conditions and setting target level

As the first step for examining the insulated building envelope planning, identify and summarize the lifestyle and housing needs of occupants and set the target level.

### 1) Desired thermal environment

- Typical indicators of the quality of indoor thermal environment in warm regions and hot humid regions including South Kyushu are the temperature irregularity (temperature difference) between the upper and lower areas of the room and between the rooms as well as the decrease in room temperature after stopping heating.
- Table 2 shows these two indicators according to the target level.
- 1) and 2) in Table 2 show the temperature difference between the heated and unheated rooms when heating is used and the difference between the outside air temperature during the dawn hours and the natural room temperature (outcome temperature), respectively. Both change according to the insulation level.
- Although the value difference in Table 2 may not seem very significant, the borderline between comfort and discomfort is markedly influenced by a small difference of 1 – 2°C.
- Based on the above information, confirm with the occupants what their desired thermal environment is before setting the target level.

Table 2 Insulation level and temperature difference

Insulation level	1) Heated and unheated rooms when heating is used	2) Outside air temperature and room temperature (natural room temperature)*
Level 0	Approx. 7°C	Approx. 4°C
Level 1	Approx. 5.5°C	Approx. 6°C
Level 2	Approx. 4°C	Approx. 7.5°C
Level 3	Approx. 3°C	Approx. 8°C
Level 4	Approx. 2.5°C	Approx. 9°C

Conditions  
House plan: Model house (Type A) (See Chapter 6)  
Heated room:  
Living/dining room  
Heating schedule:  
7:00 10:00  
12:00 14:00  
16:00 22:00  
(Set temperature: 20°C)

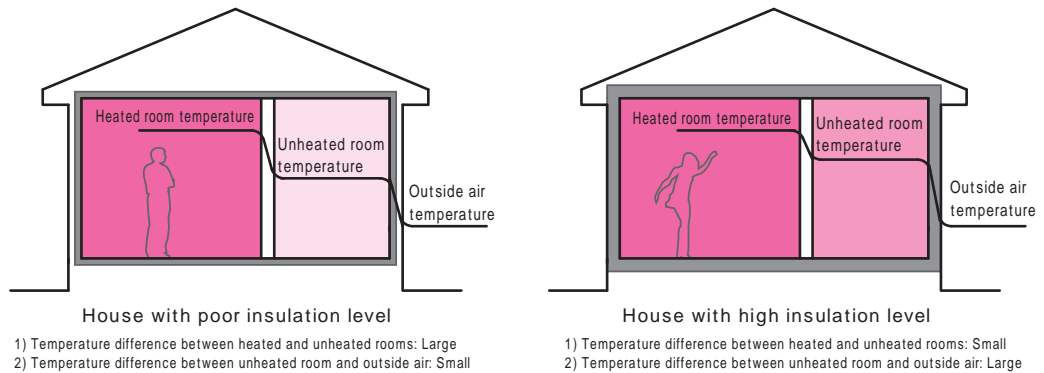

Fig. 7 Temperature difference of heated room, unheated room and outside air (concept diagram)

### 2) Energy cost efficiency resulting from increased insulation level

- If conditions such as the house plan, way of living, heating and cooling system and its operating hours are exactly the same, even a low level of insulation is definitely effective in energy and cost savings. The effect is higher as the heating duration becomes longer and the heating area becomes larger.
- Fig. 8 shows an example of annual heating and cooling cost by insulation level. The higher the insulation level the greater the energy consumption reduction. In the case of partial intermittent heating and cooling, the heating and cooling energy cost (running cost) of Level 0 decreases 21% at Level 1, 33% at Level 2, 34% at Level 3, and 40% at Level 4.
- Please refer to this information when setting the target level.



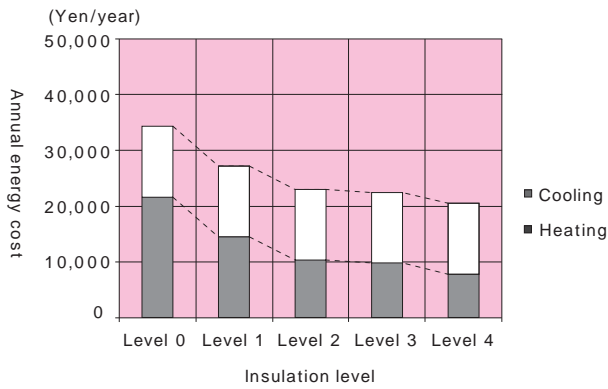

Fig. 8 Insulation level and heating and cooling cost (partial intermittent heating and cooling)

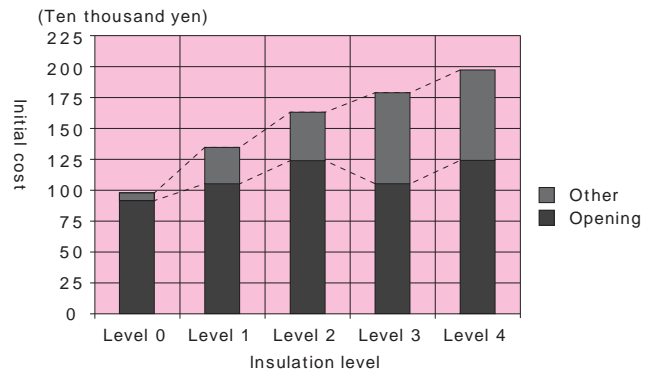

Fig. 9 Insulation level and initial cost

### 3) Initial cost due to increased insulation level

- The average rise in the initial cost due to increased insulation level is shown in Fig. 9.
- This information is based on the approximate calculation of the specifications covered in this document and should be used as a guideline.

### 4) Housing structure

- In addition to a stud wall construction and other structures and construction methods for average conventional timber frame houses, this chapter discusses mud plastered wall houses as an example of traditional conventional timber frame houses.
- Compared to stud wall houses, it is difficult to incorporate insulation into mud plastered wall houses as it is structurally challenging to fill thick insulation materials in these houses.
- Nevertheless, a number of variations are found in insulated building envelope technologies. There are insulated building envelope technologies appropriate for the construction characteristics of even mud plastered wall houses. Please refer to some of these technologies introduced in this chapter when setting the target level for insulated building envelope technology suitable for various construction methods.

## Comment High insulation level does not result in cost savings?

It has been reported that a high level of insulation does not necessary lead to reductions in heating and cooling energy (cost). Major reasons for this are as follows:

When the house is insulated, occupants leave indoor space open (e.g. leaving doors open) and the heating and cooling area tends to increase compared to before insulation is installed, resulting in increased heating and cooling energy.

Many architects, builders and occupants believe that whole-building air conditioning is

suitable for insulated houses and sometimes air conditioning planning that exceeds the needs of occupants is implemented, resulting in increased heating and cooling energy.

However, this does not mean that a high insulation level does not lead to energy saving. As described earlier, under the same conditions, housing insulation definitely achieves cost savings. Alternatively, with the same energy cost, you can heat and cool a wider area for longer hours.

# 4

## 4.1.4 Examining Insulation Planning

### 1. Selecting insulation methods

- Insulation methods of wooden houses are largely classified into the following two types: interior insulation and exterior insulation (Fig. 10).

**Interior insulation:** Refers to an insulation installation method in which insulation is installed between the structural materials such as pillars and studs, rafters and beams.

**Exterior insulation:** Refers to an insulation installation method in which a thermal barrier is installed on the exterior side of the frame and structure.

- It is not that we have to choose either of these methods and use it for insulating the entire house. As both methods have advantages and disadvantages, it is important to choose the method suitable for each component of the house. In cold regions, sometimes both interior and exterior insulation methods (also referred to as “interior and additional insulation method”) are used for the same component in order to ensure thick insulation.
- There are two types of insulation method for the top of the building (roof area): ceiling insulation and roof insulation. Of the ceiling insulation, insulation above beams is not yet commonly practiced, but this method is designed to reduce thermal bridges and it can use various insulation materials.
- The three insulation methods for the bottom of the building (floor area) are floor insulation, foundation insulation and slab on grade insulation.

Table 3 summarizes insulation methods for wooden houses by component (For details, see 5) Examining insulation method for each component in Section 4.1.5 Examining Insulation Technology on p.146).

Table 3 Insulation methods for wooden houses

Building component	Insulated component	Insulation method
Top of building (roof area)	Ceiling insulation	Interior insulation
		Exterior insulation (insulation above beams)
	Roof insulation	Interior insulation
		Exterior insulation
Exterior wall	Exterior wall insulation	Interior insulation
		Exterior insulation
		Combined insulation (interior and additional insulation)
Bottom of building (floor area)	Floor insulation	Interior insulation
	Foundation insulation	Exterior insulation (exterior or interior of foundation)
	Slab on grade insulation (slab on grade entrance, etc.)	

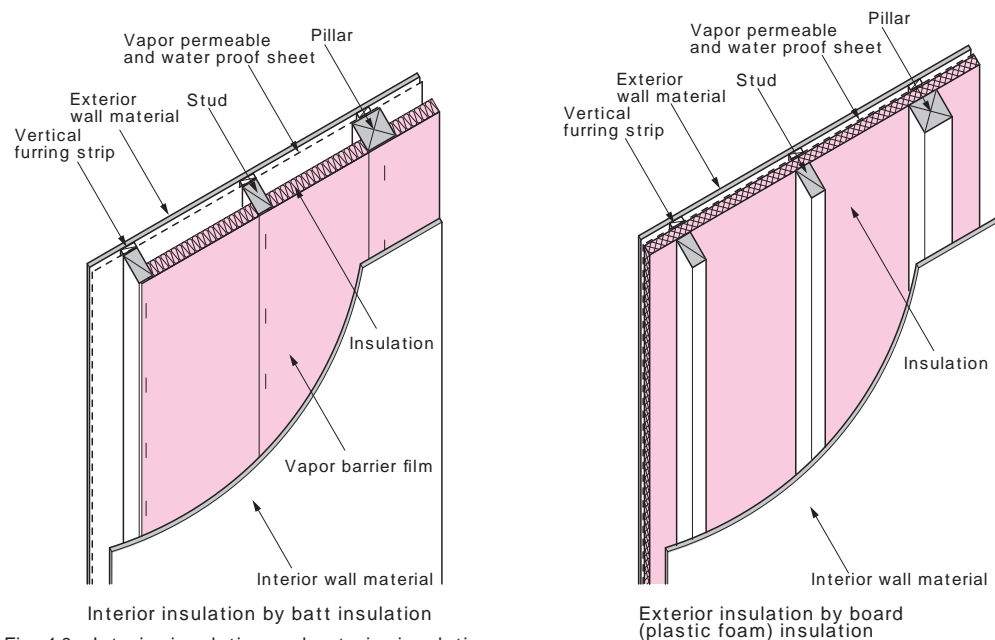

Fig. 10 Interior insulation and exterior insulation

## 2. Distribution for each building component

### 1) Evenly distributed insulation type (Fig. 11 )

Energy conservation standards stipulate the insulation standard by component (i.e. required heat resistance value and thickness of insulation) as a guideline for design and installation. The insulation standard by component is established by taking into account the balance of the insulation performance of each component (referred to as “evenly distributed insulation type” in this document). Adopting this standard helps you plan how to achieve the target level.

### 2) Partially reinforced insulation type (Fig. 11 )

Depending on the building construction method, for example in the case of a mud-plastered wall or Japanese style wall construction method, it is difficult to install thick insulation materials in the exterior wall. If this is the case, reinforcing the insulation of other components than the exterior wall will reduce the insulation requirement of the exterior wall (referred to as “partially reinforced insulation type” in this document).

4.1.6 Examples of Insulation Planning shows specific insulation examples by target level (See pp.155-163).

For the evenly distributed insulation type, three cases of interior insulation, insulation above beams/foundation insulation and exterior insulation are presented for Level 3.

For the partially reinforced insulation type, five cases of reinforced insulation at the ceiling and openings are shown for Level 1 to 3, in consideration of heat protection and control measures in summer for Zone V, which is a hot humid region according to the zone classification of energy conservation standard.

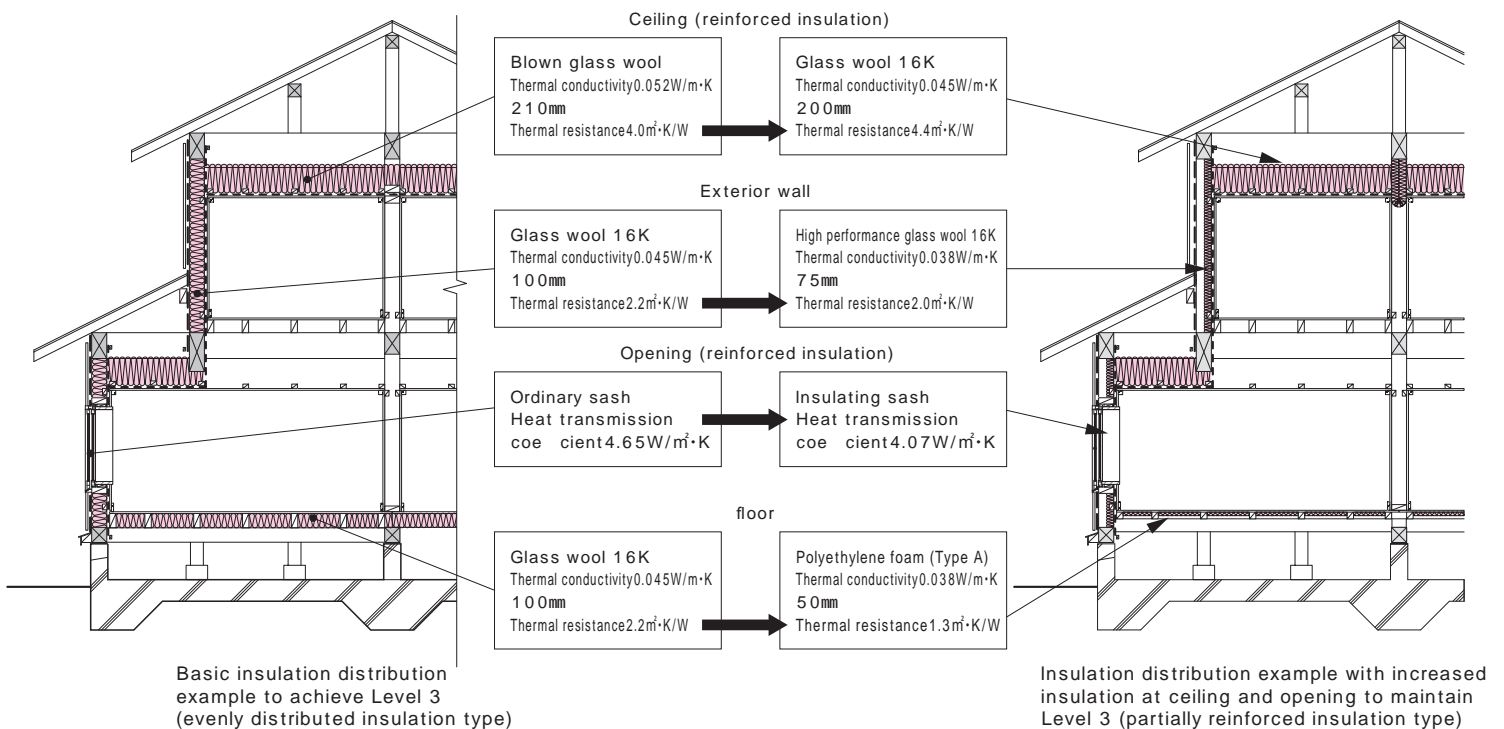

Fig. 11 Insulation planning methods (distribution to components)

**Thermal conductivity :** A measure of a material's ability to conduct heat. The amount of heat flow through a material of unit area and unit thickness in unit time when there is a temperature difference of 1°C between its surfaces (Units are W/m·K).

**Thermal resistance :** A measure of a material's ability to resist heat conduction (Units are m²·K/W).

**Heat transmission coefficient :** The amount of heat flow per unit area and unit time when there is an air temperature difference between surfaces of windows, walls, etc. (Units are W/m²·K). Heat transmission coefficient is used to express insulation performance of window sashes.

# 4

## 4.1.5 Examining Insulation Technology

This section explains insulation technology for building envelopes and openings. Insulation technology has significantly advanced as the need for energy conservation has become widely recognized. Flaws of building envelopes, such as sagging after installation, have been solved since insulation materials and their installation methods have greatly improved. Insulating sashes that are excellent in both quality and performance are available for openings.

### 1. Examining insulation technology for building envelopes

The insulation performance we aim for cannot be achieved by simply filling insulation materials into the walls. Moreover, it is necessary to address internal condensation and other obstacles. This section explains insulation technology for building envelopes which are the basics of insulation. Table 4 shows a list of thermal conductivity of insulation materials and minimum thickness to obtain the required thermal resistance.

#### 1) Types and characteristics of insulation materials

Major types and characteristics of insulation materials are as shown below:

##### Batt insulation

Batt insulation refers to fiber insulation materials such as glass wool and rock wool. This insulation material can be used in a wide range of components and is most commonly used because of its size adjustability, ease of cutting and installation, low cost and incombustibility. Some disadvantages are that its breathability decreases its insulation performance if there is airflow in the thermal barrier and its flexibility tends to cause variable insulation performance depending on the installation quality. For that reason, it is necessary to ensure ventilation control at the connections between the walls and the floors and ceilings in order to prevent airflow within the walls and insulation materials. It also requires that insulation materials are properly and firmly installed in the required areas inside the building envelope.

##### Blown-in insulation

This is a type of loose-fill insulation that is blown into the ceiling, roof, walls and other components. Examples of materials include glass wool, rock wool and cellulose fiber. Even though its insulation performance is slightly lower than that of batt insulation when comparing materials with the same thickness, it is generally easy to install especially for ceiling insulation.

##### Board insulation

This insulation material is often used in the exterior insulation method for floor insulation and on the outside of the building frame. Types of materials include plastic foam insulation materials such as extruded polystyrene foam, expanded polystyrene foam, rigid urethane foam, polyethylene foam and phenolic foam, as well as glass wool and rock wool. Generally, it has higher insulation performance than batt insulation when comparing materials with the same thickness.

The finer the foam and the higher the structural independence, the greater the insulation performance of plastic board insulation. Additionally, owing to its low water absorption rate, this material is less susceptible to moisture problems found with batt insulation. The disadvantage is that it needs to be used with a fire-resistant exterior finish when installed on the exterior side of the frame or structure as it is prone to fire and UV damage.

##### Foamed-in-place insulation

Foamed-in-place insulation materials such as spray urethane foam insulation are best characterized by their ease of installation. Nevertheless, there are some cases in which insulation is installed with an improper expansion ratio and installation environment. It is important to follow the installation specification.

#### Note

With regard to urethane foam and extruded polystyrene foam insulation, CFC-free materials should be used from this point forward, from the perspective of preventing global warming and ozone depletion.

Table 4 Quick reference for minimum thickness (d) of insulation materials to obtain required thermal resistance (Unit: mm)  $d = \lambda R_c \times 1000$

	Thermal conductivity Unit:W/m·K																										
	0.052	0.051	0.050	0.049	0.047	0.045	0.044	0.043	0.042	0.040	0.039	0.038	0.037	0.036	0.035	0.034	0.033	0.032	0.030	0.029	0.028	0.027	0.026	0.024	0.023	0.022	
Thermal resistance value $R_c$ (m <sup>2</sup> ·K/W)	0.2	11	11	10	10	10	9	9	9	9	8	8	8	8	7	7	7	7	6	6	6	6	6	5	5	5	
	0.3	16	16	15	15	15	14	14	13	13	12	12	12	12	11	11	11	10	10	9	9	9	9	8	8	7	7
	0.4	21	21	20	20	19	18	18	18	17	16	16	16	15	15	14	14	14	13	12	12	12	11	11	10	10	9
	0.5	26	26	25	25	24	23	22	22	21	20	20	19	19	18	18	17	17	16	15	15	14	14	13	12	12	11
	0.6	32	31	30	30	29	27	27	26	26	24	24	23	23	22	21	21	20	20	18	18	17	17	16	15	14	14
	0.7	37	36	35	35	33	32	31	31	30	28	28	27	26	26	25	24	24	23	21	21	20	19	19	17	17	16
	0.8	42	41	40	40	38	36	36	35	34	32	32	31	30	29	28	28	27	26	24	24	23	22	21	20	19	18
	0.9	47	46	45	45	43	41	40	39	38	36	36	35	34	33	32	31	30	29	27	27	26	25	24	22	21	20
	1.0	52	51	50	49	47	45	44	43	42	40	39	38	37	36	35	34	33	32	30	29	28	27	26	24	23	22
	1.1	58	57	55	54	52	50	49	48	47	44	43	42	41	40	39	38	37	36	33	32	31	30	29	27	26	25
	1.2	63	62	60	59	57	54	53	52	51	48	47	46	45	44	42	41	40	39	36	35	34	33	32	29	28	27
	1.4	73	72	70	69	66	63	62	61	59	56	55	54	52	51	49	48	47	45	42	41	40	38	37	34	33	31
	1.5	78	77	75	74	71	68	66	65	63	60	59	57	56	54	53	51	50	48	45	44	42	41	39	36	35	33
	1.7	89	87	85	84	80	77	75	74	72	68	67	65	63	62	60	58	57	55	51	50	48	46	45	41	40	38
	1.8	94	92	90	89	85	81	80	78	76	72	71	69	67	65	63	62	60	58	54	53	51	49	47	44	42	40
	2.0	104	102	100	98	94	90	88	86	84	80	78	76	74	72	70	68	66	64	60	58	56	54	52	48	46	44
	2.1	110	108	105	103	99	95	93	91	89	84	82	80	78	76	74	72	70	68	63	61	59	57	55	51	49	47
	2.2	115	113	110	108	104	99	97	95	93	88	86	84	82	80	77	75	73	71	66	64	62	60	58	53	51	49
	2.3	120	118	115	113	109	104	102	99	97	92	90	88	86	83	81	79	76	74	69	67	65	63	60	56	53	51
	2.5	130	128	125	123	118	113	110	108	105	100	98	95	93	90	88	85	83	80	75	73	70	68	65	60	58	55
	2.6	136	133	130	128	123	117	115	112	110	104	102	99	97	94	91	89	86	84	78	76	73	71	68	63	60	58
	2.7	141	138	135	133	127	122	119	117	114	108	106	103	100	98	95	92	90	87	81	79	76	73	71	65	63	60
	2.9	151	148	145	143	137	131	128	125	122	116	114	111	108	105	102	99	96	93	87	85	82	79	76	70	67	64
	3.0	156	153	150	147	141	135	132	129	126	120	117	114	111	108	105	102	99	96	90	87	84	81	78	72	69	66
	3.1	162	159	155	152	146	140	137	134	131	124	121	118	115	112	109	106	103	100	93	90	87	84	81	75	72	69
	3.2	167	164	160	157	151	144	141	138	135	128	125	122	119	116	112	109	106	103	96	93	90	87	84	77	74	71
3.3	172	169	165	162	156	149	146	142	139	132	129	126	123	119	116	113	109	106	99	96	93	90	86	80	76	73	
3.5	182	179	175	172	165	158	154	151	147	140	137	133	130	126	123	119	116	112	105	102	98	95	91	84	81	77	
3.6	188	184	180	177	170	162	159	155	152	144	141	137	134	130	126	123	119	116	108	105	101	98	94	87	83	80	
3.8	198	194	190	187	179	171	168	164	160	152	149	145	141	137	133	130	126	122	114	111	107	103	99	92	88	84	
4.0	208	204	200	196	188	180	176	172	168	160	156	152	148	144	140	136	132	128	120	116	112	108	104	96	92	88	
4.1	214	210	205	201	193	185	181	177	173	164	160	156	152	148	144	140	136	132	123	119	115	111	107	99	95	91	
4.2	219	215	210	206	198	189	185	181	177	168	164	160	156	152	147	143	139	135	126	122	118	114	110	101	97	93	
4.5	234	230	225	221	212	203	198	194	189	180	176	171	167	162	158	153	149	144	135	131	126	122	117	108	104	99	
4.6	240	235	230	226	217	207	203	198	194	184	180	175	171	166	161	157	152	148	138	134	129	125	120	111	106	102	
5.0	260	255	250	245	235	225	220	215	210	200	195	190	185	180	175	170	165	160	150	145	140	135	130	120	115	110	
5.2	271	266	260	255	245	234	229	224	219	208	203	198	193	188	182	177	172	167	156	151	146	141	136	125	120	115	
5.5	286	281	275	270	259	248	242	237	231	220	215	209	204	198	193	187	182	176	165	160	154	149	143	132	127	121	
5.7	297	291	285	280	268	257	251	246	240	228	223	217	211	206	200	194	189	183	171	166	160	154	149	137	132	126	
6.0	312	306	300	294	282	270	264	258	252	240	234	228	222	216	210	204	198	192	180	174	168	162	156	144	138	132	
6.6	344	337	330	324	311	297	291	284	278	264	258	251	245	238	231	225	218	212	198	192	185	179	172	159	152	146	
Residential glass wool insulation			10K			16K			20K			24K		32K													
High performance glass wool insulation												16K		24K	32K	40K	48K										
Blown glass wool insulation	GW-1 · GW-2 ( )									30K · 35K																	
Residential rock wool insulation												Mat · Batt		Board													
Blown rock wool insulation				25K						65K																	
Type A expanded polystyrene foam board insulation								No.4	No.3			No.2	No.1	Special													
Type A extruded polystyrene foam board insulation									Type 1						Type 2							Type 3					
Type A rigid urethane foam board insulation																				Type 1	Type 2 No.4	Type 2 No.3		Type 2 No.2	Type 2 No.1		
Spray rigid urethane foam for building insulation									Type A3										Type A1 · Type A2								
Type A polyethylene foam board insulation									Type 1 No.1 · Type 1 No.2			Type 2				Type 3											
Type A phenolic foam board insulation														Type 2 No.1	Type 3 No.1 · Type 3 No.2	Type 2 No.2					Type 2 No.3					Type 1 No.1 · Type 1 No.2	
Blown cellulose fiber insulation									25K · 45K · 55K																		
Insulation material group	A1		A2						B						C												F

K = kg/m<sup>3</sup> (density) \* GW-1: 13K installation density; GW-2: 18K installation density

Source: Explanation of Energy Conservation Standards for Housing (Third Revision), Institute for Building Environment and Energy Conservation, p.1 14

How to use Table 4 (example)

E.g. 1: To find the thermal conductivity of Type A polyethylene foam board insulation (Type 2), search Type 2 in the applicable row towards the right and go up the column until you reach 0.038 W/m · K of thermal conductivity at the top of the table.

E.g. 2: The required thickness for residential glass wool insulation 16K to achieve a thermal resistance value of 4.0 m<sup>2</sup> · K/W is 180 mm, which can be obtained by finding where the column of residential glass wool insulation 16K meets the row of target thermal resistance of 4.0. The thermal conductivity of residential glass wool insulation 16K is 0.045 W/m · K.

# 4

## 2) Basic structure of thermal barrier

- When there are four family members in the house, about 3 to 5 L of moisture is generated per day from their bodies and daily activities. If this moisture penetrates the walls and roof and remains there in winter, it is cooled and results in internal condensation. To prevent this, we need to take measures such as installing a vapor barrier<sup>1</sup> as continuous as possible on the interior side of the insulation.

- There is a risk of condensation caused by moisture that has seeped through small gaps in the vapor barrier as well as contained in insulation, wood and plywood that remains in the insulation.

To prevent this and promote drying of the interior of the structure, a ventilated cavity is installed in the exterior wall and underfloor ventilation and attic ventilation are ensured to expose the exterior side of the insulation to the outside air (Fig. 13).

- When using glass wool and other fiber insulation materials, it is necessary to install a vapor-permeable weather barrier<sup>2</sup> which resists wind on the exterior side of the insulation. Waterproof or water-repellent materials should be selected for the weather barrier materials so that the rain seeping from the exterior finish and other materials does not wet the interior of the structure.

- As discussed above, the basic structure of the thermal barrier consists of a highly vapor resistant vapor barrier on the interior side of the insulation, a weather barrier that is vapor-permeable, wind-resistant and waterproof on the exterior side of the insulation, and a ventilated cavity (Fig. 12).

- Approximately 30 m<sup>2</sup> of lumber is used in an average wooden house. Once the house is built, moisture contained in the lumber is released into the walls and other structural components. Because of this moisture, there are quite a few risks of temporary internal condensation and it is important to use dried wood (gravimetric moisture content of 20% or below) for preventing internal condensation.

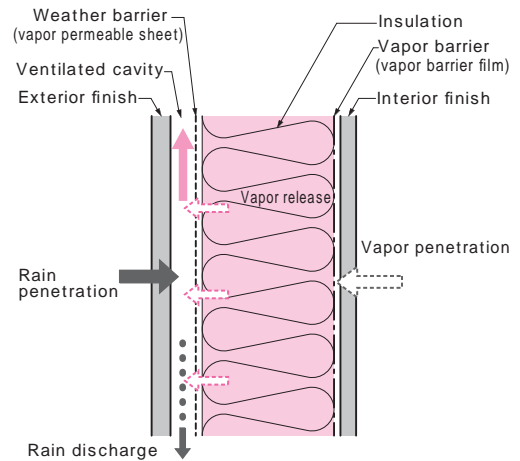
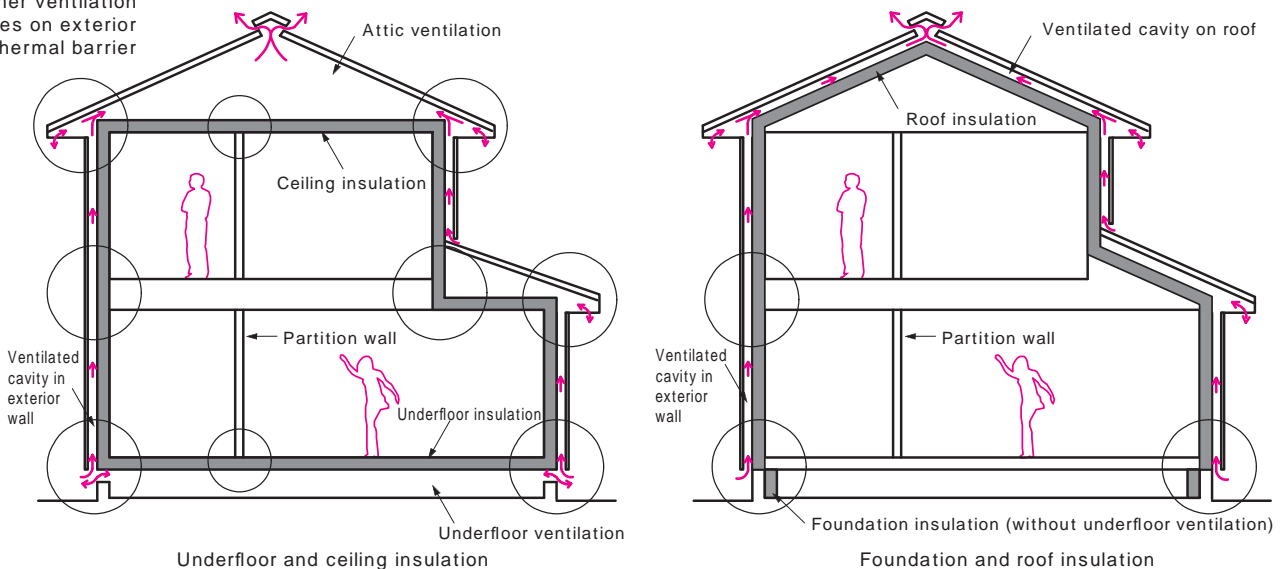

Fig. 12 Basic structure of thermal barrier (exterior wall)

1. Vapor barrier : This building layer prevents moisture generated indoors from seeping into the structure. Vapor barrier films can be used as vapor barrier materials and plywood is also acceptable for some components. For vapor barrier films, you can either use an integral vapor barrier that is attached to an insulation material or install a separate vapor barrier.
2. Weather barrier : This building layer requires vapor permeability that removes moisture to maintain insulation effectiveness and structural durability, wind resistance to prevent cold air from entering into the structure, and waterproof or water-repellent properties to keep the rain leaked through an exterior finish and other materials from seeping into the structure. Vapor permeable sheets and other weather barrier materials are used to create this layer.

Fig. 13  
Ventilated cavity and  
other ventilation  
schemes on exterior  
side of thermal barrier



### 3) Installing airflow blocking

In conventional timber frame construction, structural cavities, such as crawl space, inside the walls and attic space, were continuous, and airflow inside the envelope generated in these spaces helped keep pillars, beams and other structural lumber dry.

However, since the interior insulation method used in many of today’s insulated houses requires insulation materials to be installed within the structure, a sufficient level of insulation may not be maintained if there is airflow inside the envelope. In order to fully demonstrate effective insulation, it is necessary to block the airflow from the crawl space to the walls (exterior and partition walls) as well as from the walls to the attic space. To achieve this, you can install airflow blocking along the top and bottom of the walls.

Airflow blocking is required for the interior insulation method, but unnecessary when insulating the roof and foundation in addition to using the exterior insulation method for exterior walls.

The following are four types of major airflow blocking methods:

- Method 1** Airflow blocking by subfloor plywood, interior sheathing board and other sheet materials  
This method blocks airflow by using sheet materials such as subfloor plywood, wall and ceiling plasterboard. If Level 3 or 4 insulation is desired, airflow blocking of connections between the exterior walls and the attic (ceiling) requires the use of both airflow blocking and vapor barrier film. Vapor barrier film is not needed for partition walls or if plywood or tongue and groove flooring is used for the floor.
- Method 2** Airflow blocking by piece of wood  
This airflow blocking method involves installation of the required size of lumber that can block the airflow path.
- Method 3** Airflow blocking by vapor barrier film and bracing or other materials  
This method blocks airflow by installing vapor barrier film. The edges of the vapor barrier film should not only simply be stapled, but also be firmly sandwiched between the backing (e.g. cross beam) or bolster and the vapor barrier film bracing (lumber of at least 40 mm wide by 15 mm thick).
- Method 4** Airflow blocking by dedicated and other materials  
With this method, airflow is blocked by simply installing dedicated glass wool materials and fastening the vapor barrier film to the cross beams. It can be used only for either Level 1 or 2, not Level 3 or 4 which requires more complete airflow blocking.

Table 5 summarizes the installation locations and methods of airflow blocking. The next pages will explain design examples of airflow blocking of each component by installation method. Any combination can be used, for example, Method 1 for the connections with the floor and Method 2 for the connections with the attic (ceiling). Please refer to these pages for planning airflow blocking design.

Table 5 Airflow blocking methods by component

Airflow blocking location		Airflow blocking method	Applicable insulation level
Exterior wall	Connections with attic (ceiling)	Method 1 Airflow blocking by vapor barrier film + interior sheathing board	Levels 1 4
		Method 2 Airflow blocking by piece of wood	
		Method 3 Airflow blocking by vapor barrier film and bracing	
		Method 4 Airflow blocking by vapor barrier film only	Levels 1, 2
	Connections with floor	Method 1 Airflow blocking by subfloor plywood	Levels 1 4
		Method 2 Airflow blocking by piece of wood	
		Method 3 Airflow blocking by vapor barrier film and bolster	
		Method 4 Airflow blocking by dedicated material	Levels 1, 2
Partition wall	Connections with attic (ceiling)	Method 1 Airflow blocking by vapor barrier film + ceiling sheathing board	Levels 1 4
		Method 2 Airflow blocking by piece of wood	
		Method 4 Airflow blocking by dedicated material	Levels 1, 2
	Connections with floor	Method 1 Airflow blocking by subfloor plywood	Levels 1 4
		Method 2 Airflow blocking by piece of wood	
		Method 4 Airflow blocking by dedicated material	Levels 1, 2

**Glossary: Airflow blocking**  
Upon the revision of the energy conservation standards for housing in April 2009, airflow prevention of the interior of walls was included as part of the installation requirements. Although the same concept, the warm region edition guideline refers to it as “ventilation control” while this and future guidelines will call it “airflow blocking” in accordance with the energy conservation standards.

# 4

Exterior wall 1 (If interior wall is stud wall)

Chapter 4  
Heat Control Technology of  
Building Envelopes  
(Elemental Technology  
Application Method 2)

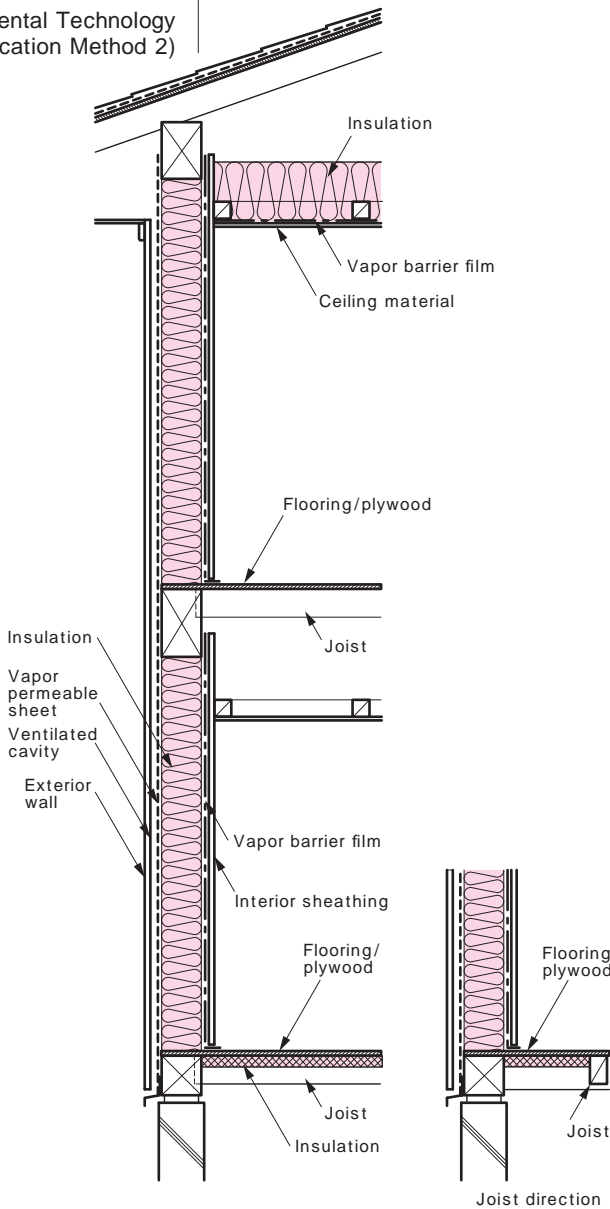

Fig. 14 Example of airflow blocking by Method 1

- Connections with attic (ceiling)  
(Airflow blocking by vapor barrier film + interior sheathing board)
- Connections with floor  
(Airflow blocking by subfloor plywood)

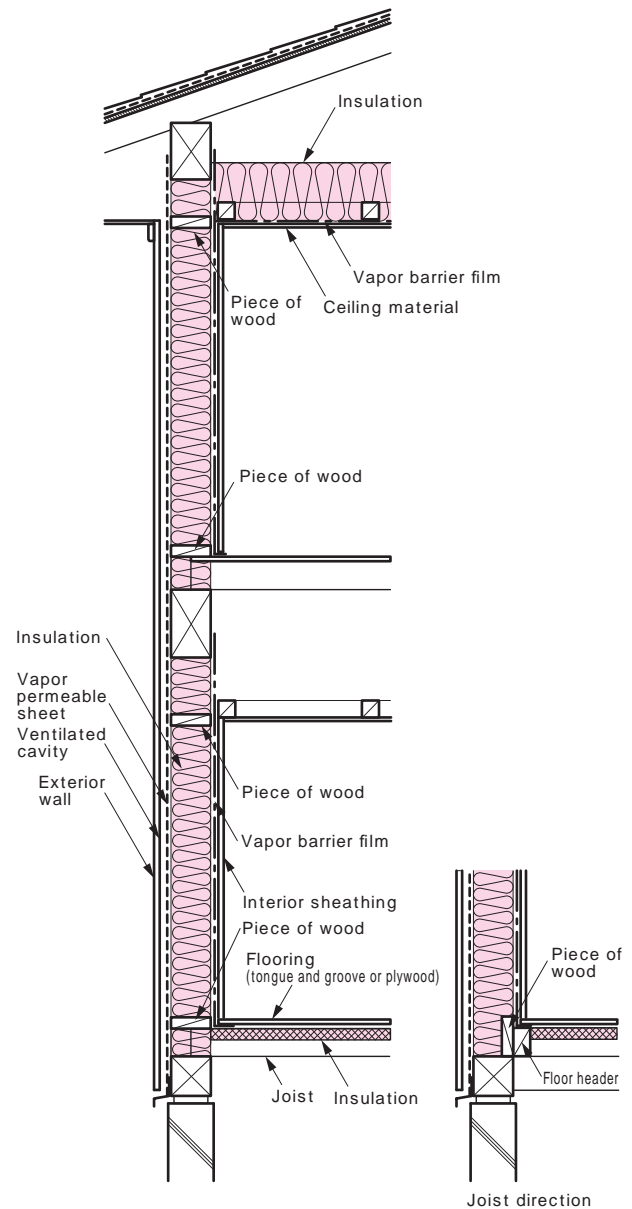

Fig. 15 Example of airflow blocking by Method 2

- Connections with attic (ceiling)  
(Airflow blocking by sticker)
- Connections with floor  
(Airflow blocking by sticker)





# 4

Exterior wall 2 (If interior wall is stud wall covered with sheet material)

Chapter 4  
Heat Control Technology of  
Building Envelopes  
(Elemental Technology  
Application Method 2)

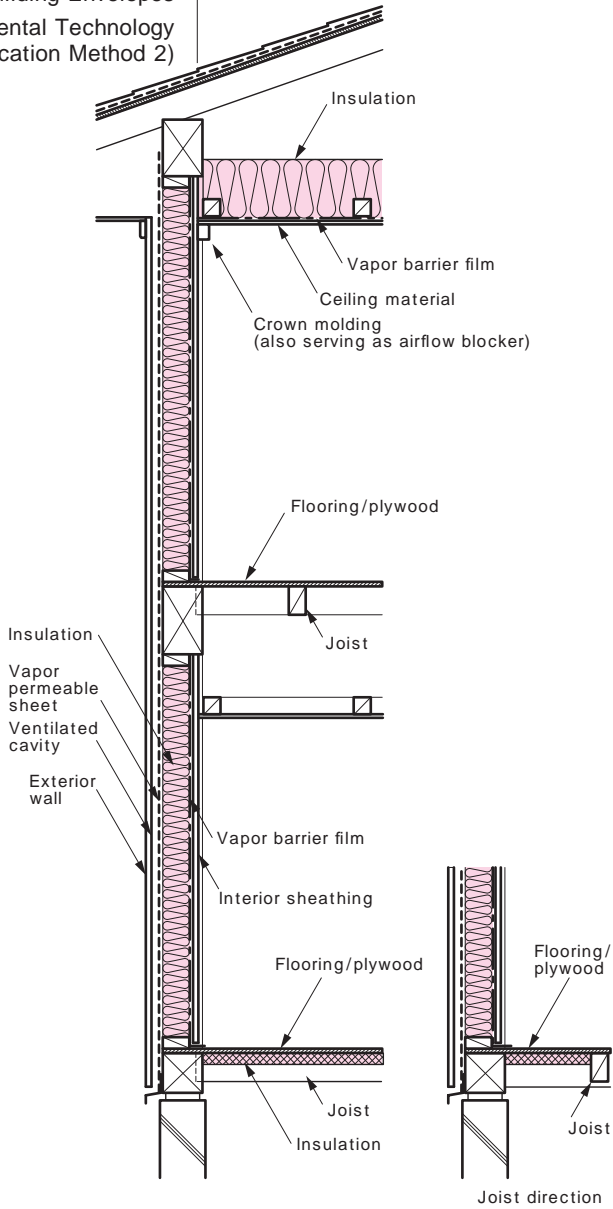

Fig. 18 Example of airflow blocking by Method 1

- Connections with attic (ceiling)  
(Airflow blocking by vapor barrier film + interior sheathing board)
- Connections with floor  
(Airflow blocking by subfloor plywood)

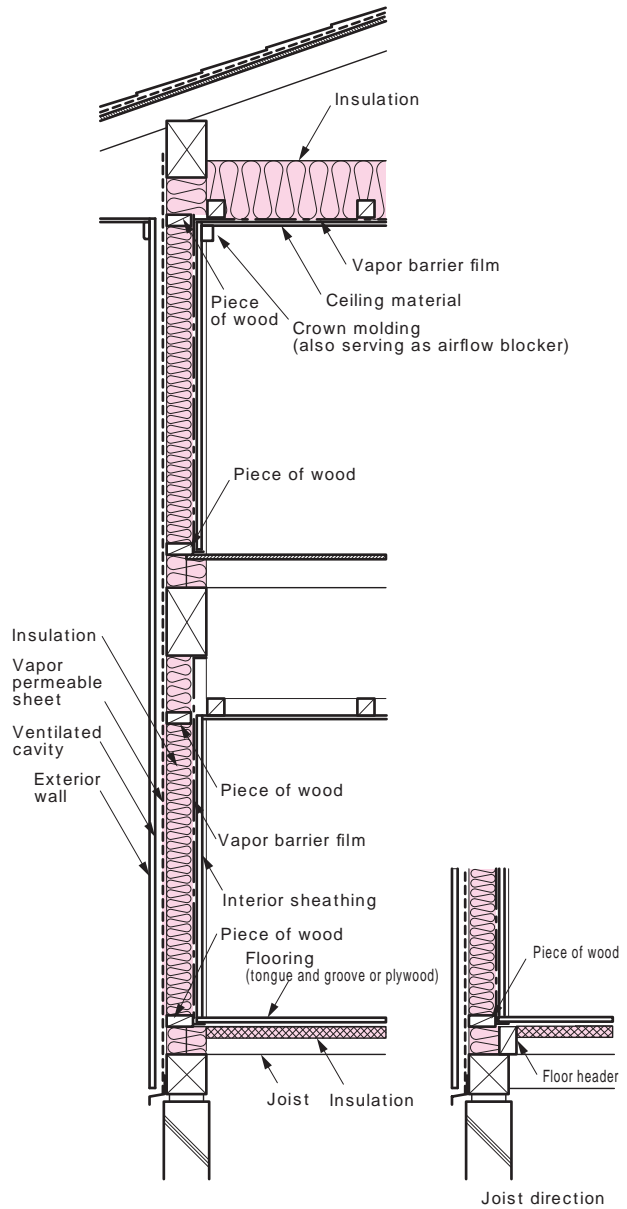

Fig. 19 Example of airflow blocking by Method 2

- Connections with attic (ceiling)  
(Airflow blocking by piece of wood)
- Connections with floor  
(Airflow blocking by piece of wood)

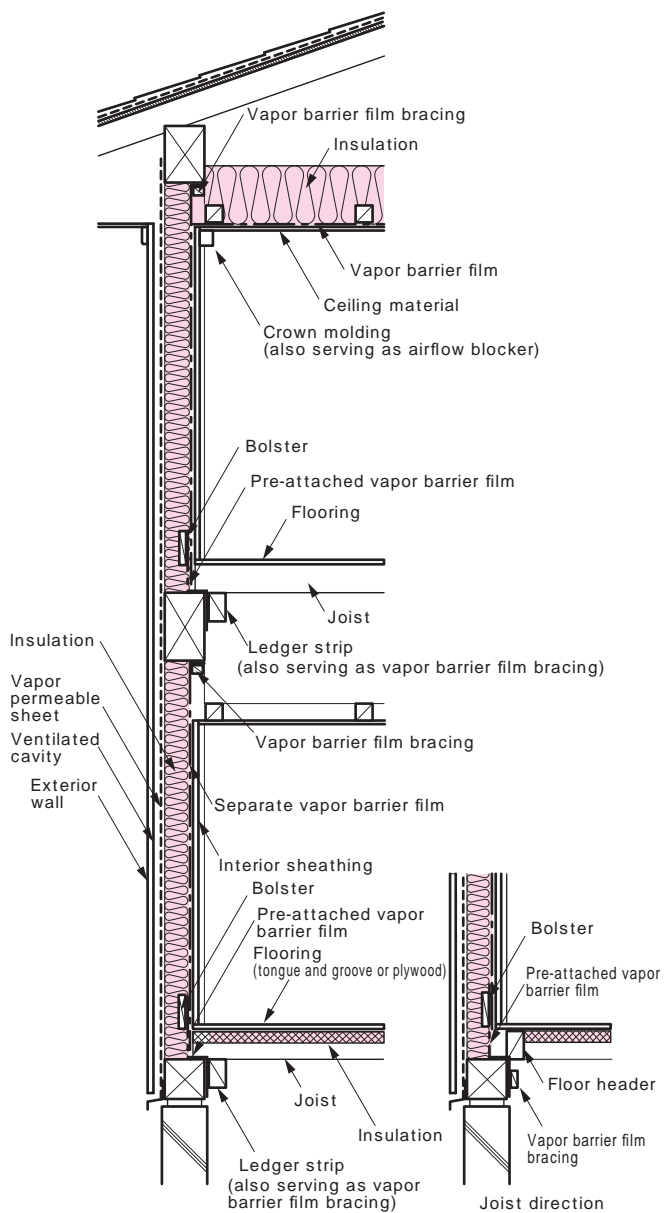



Fig. 20 Example of airflow blocking by Method 3

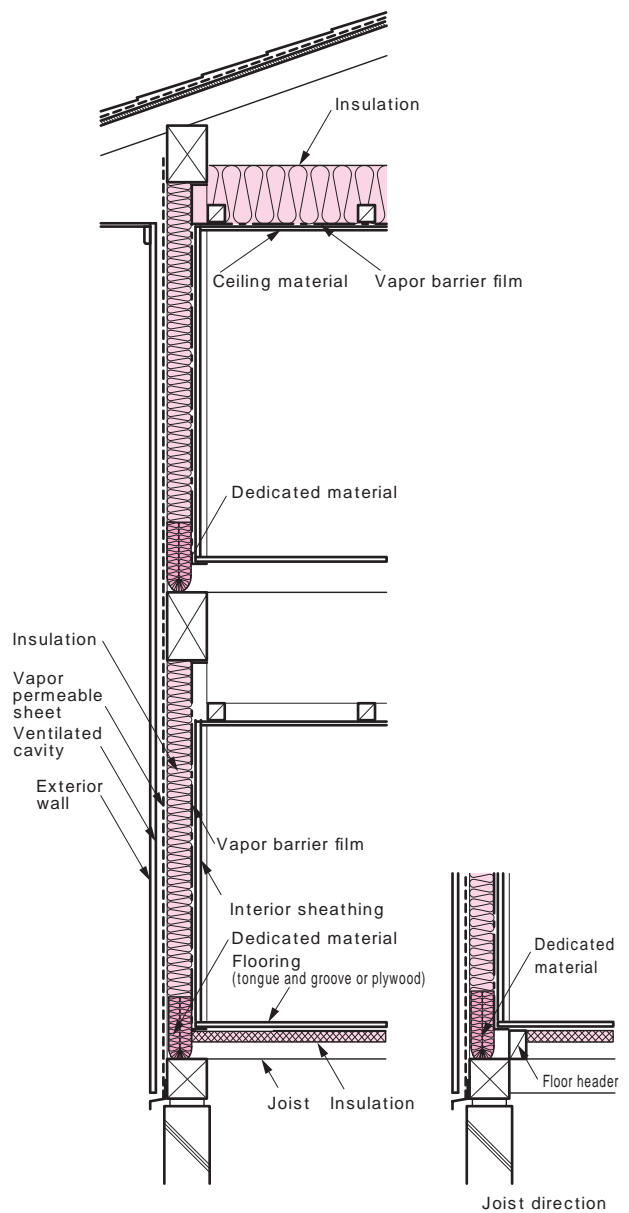

Fig. 21 Example of airflow blocking by Method 4

- Connections with attic (ceiling)  
(Airflow blocking by vapor barrier film and bracing)
- Connections with floor  
(Airflow blocking by vapor barrier film and bolster)

- Connections with attic (ceiling)  
(Airflow blocking by vapor barrier film only)  
<Applicable to Levels 1 and 2 only>
- Connections with floor  
(Airflow blocking by dedicated material)  
<Applicable to Levels 1 and 2 only>

Exterior wall 3  
(If interior wall is load-bearing stud wall panel)

Exterior wall 4  
(If interior wall is load-bearing Japanese style wall panel)

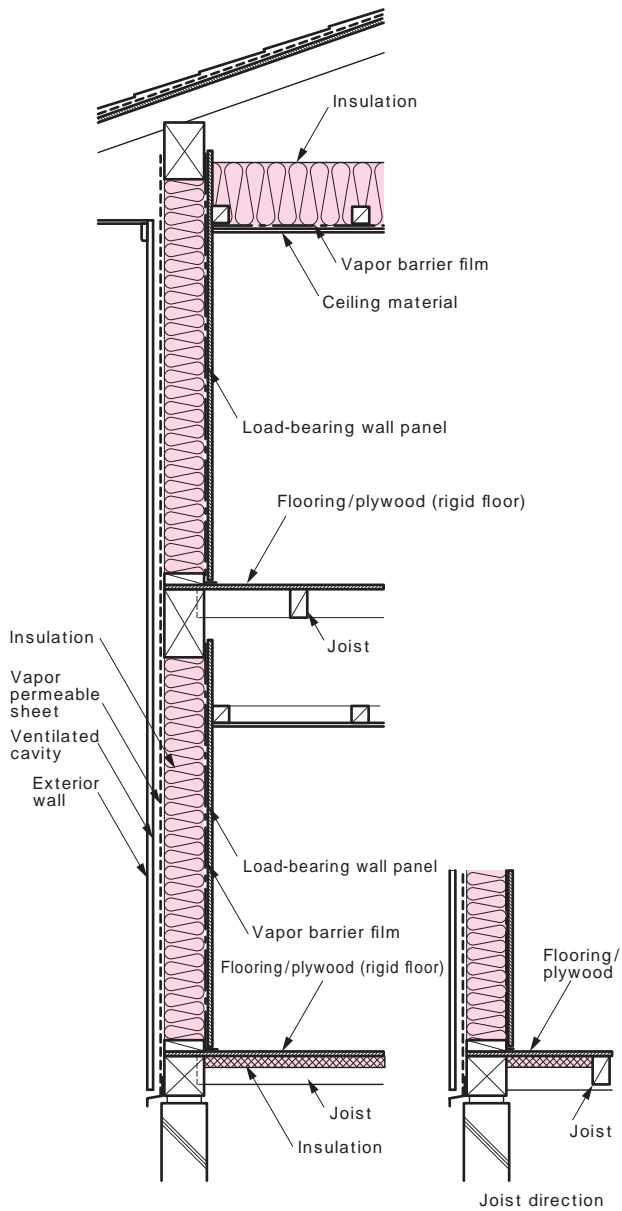

Fig. 22 Example of airflow blocking by Method 1

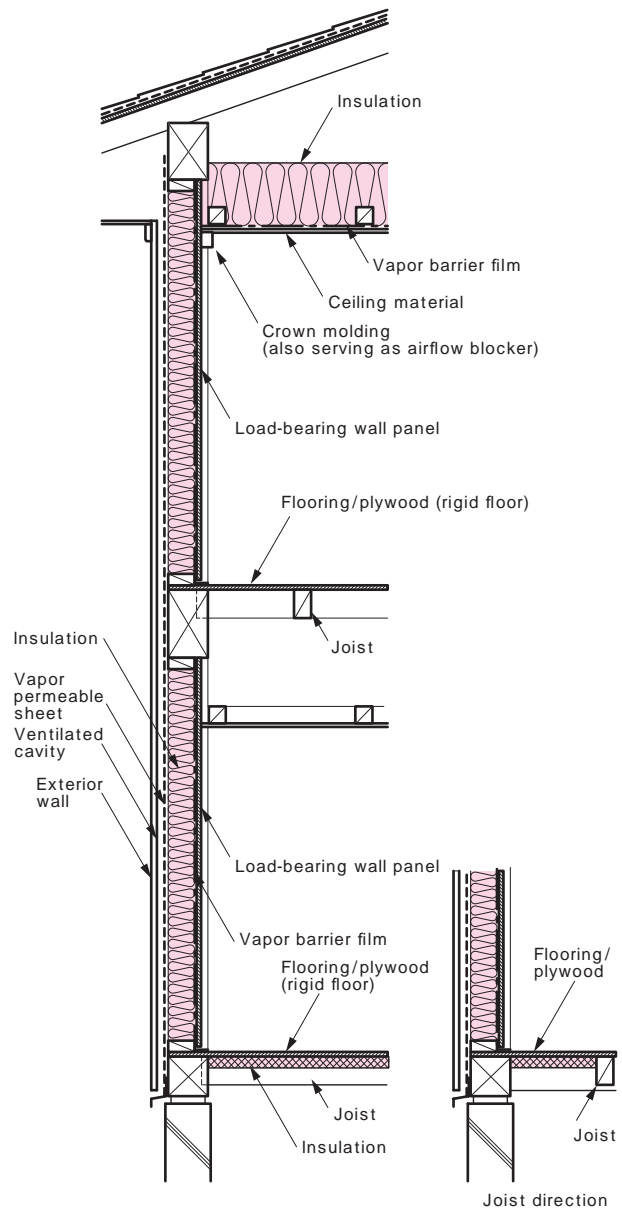

Fig. 23 Example of airflow blocking by Method 1

\* This example uses load-bearing wall panel as interior wall although airflow blocking principles are the same as the example in Fig. 14.

- Connections with attic (ceiling)  
(Airflow blocking by vapor barrier film + load-bearing wall panel)
- Connections with floor  
(Airflow blocking by subfloor plywood)

\* This example uses load-bearing wall panel as interior wall although airflow blocking principles are the same as the example in Fig. 18.

- Connections with attic (ceiling)  
(Airflow blocking by vapor barrier film + load-bearing wall panel)
- Connections with floor  
(Airflow blocking by subfloor plywood)

Exterior wall 5 (In case of mud-plastered wall)

Figs. 24 and 25 show design examples of wall assemblies and connections between walls and floors and walls and ceilings. Since mud-plastered walls have a high moisture capacity, no vapor barrier film is required on the interior side. Moreover, as it structurally blocks airflow, there is no need to install airflow blocking.

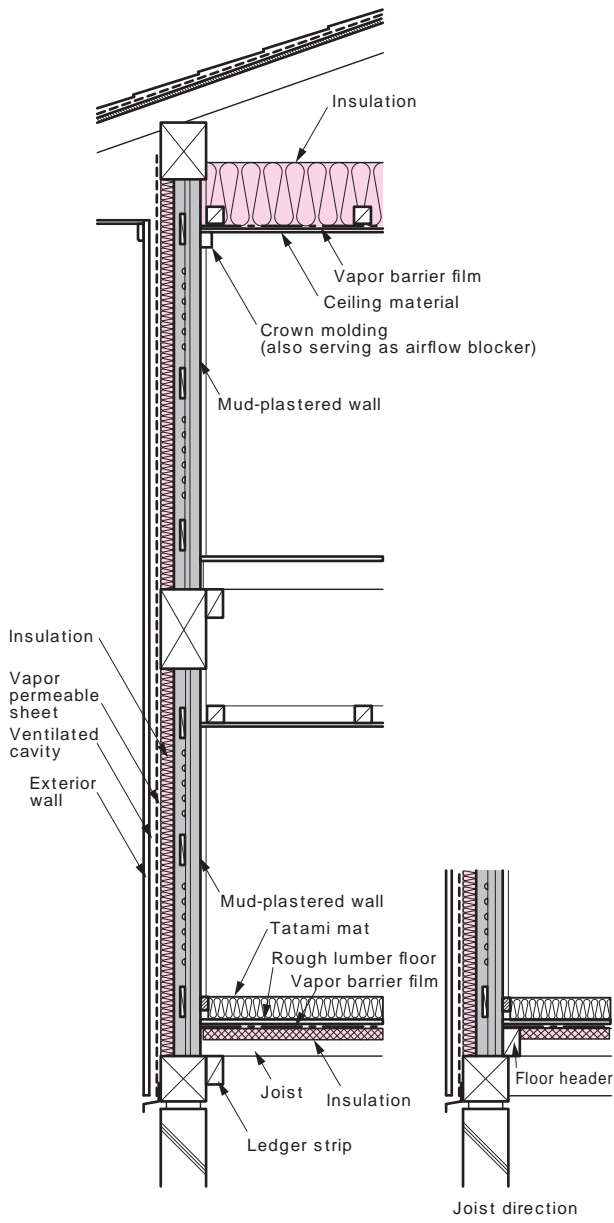



Fig. 24 Interior insulation

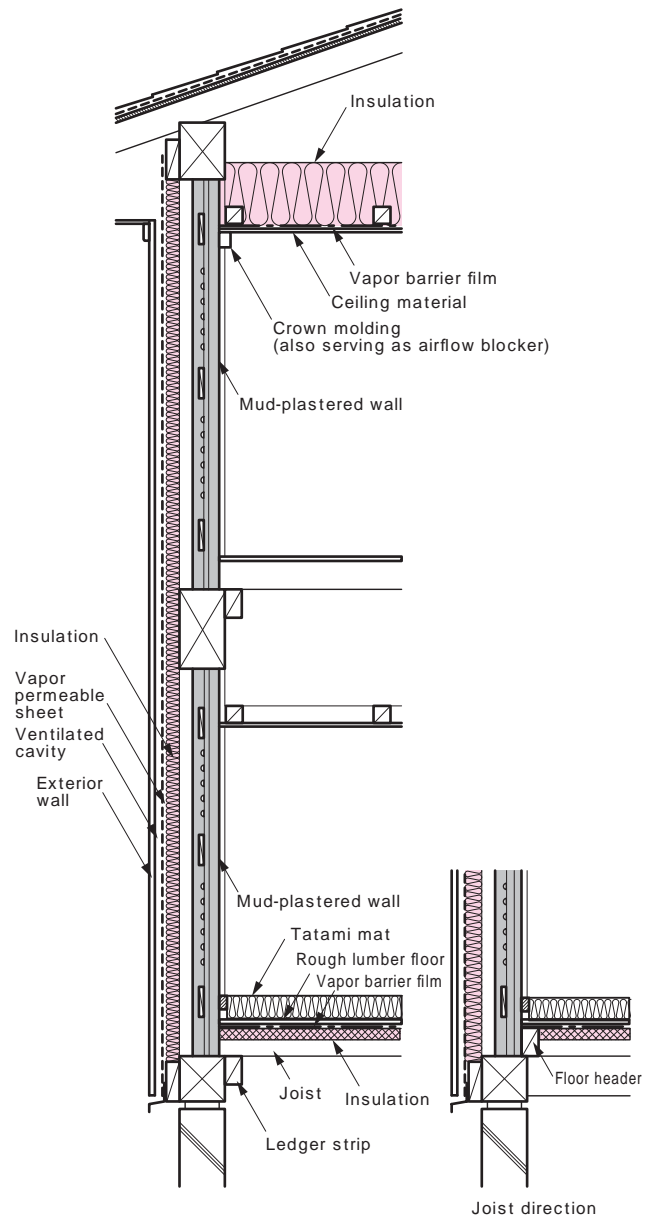

Fig. 25 Exterior insulation

# 4

## Partition wall 1 (Non-load-bearing wall)

The ceiling crawl space on the first floor of a two-storey house that is not in contact with the outside air is thought to have the same thermal environment as the indoor space, thus airflow blocking is unnecessary. The areas that require airflow blocking of partition walls are connections between the crawl space of the lowest floor and the partition walls as well as between the partition walls and the attic space.

Chapter 4  
Heat Control Technology of  
Building Envelopes  
(Elemental Technology  
Application Method 2)

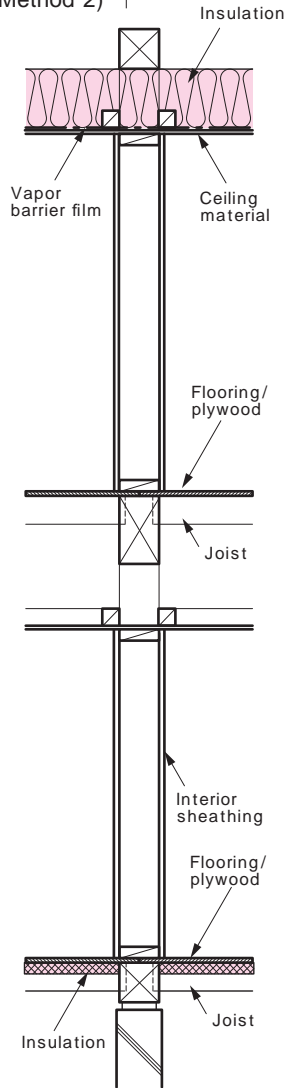

Fig. 26 Example of airflow blocking by Method 1

- Connections with attic (ceiling)  
(Airflow blocking by vapor barrier film + ceiling sheathing board)
- Connections with floor  
(Airflow blocking by subfloor plywood)

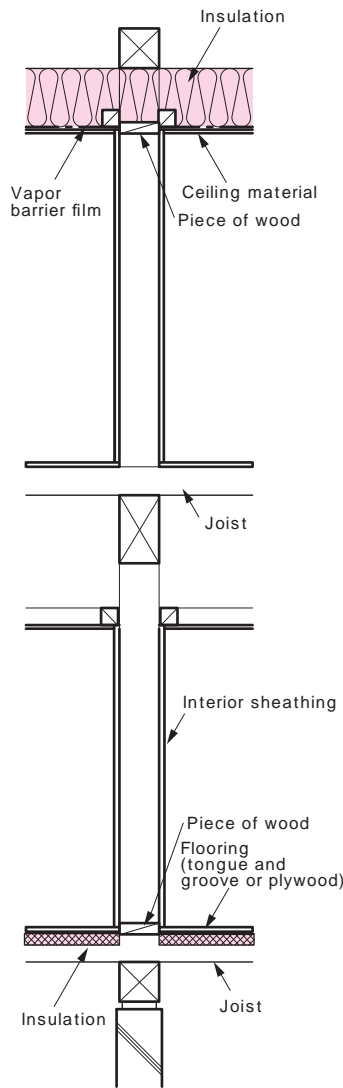

Fig. 27 Example of airflow blocking by Method 2

- Connections with attic (ceiling)  
(Airflow blocking by piece of wood)
- Connections with floor  
(Airflow blocking by piece of wood)

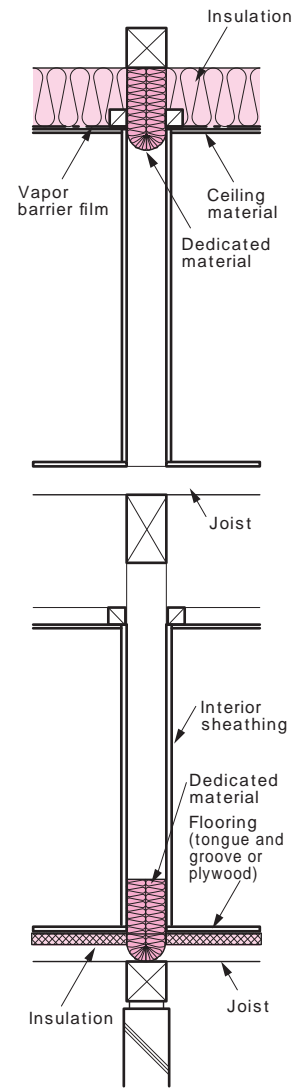

Fig. 28 Example of airflow blocking by Method 4

- Connections with attic (ceiling)  
(Airflow blocking by dedicated material)  
<Applicable to Levels 1 and 2 only>
- Connections with floor  
(Airflow blocking by dedicated material)  
<Applicable to Levels 1 and 2 only>

Partition wall 2  
(Load-bearing stud wall panel)

Partition wall 3  
(Load-bearing Japanese style wall panel)

Partition wall 4  
(Mud-plastered wall)

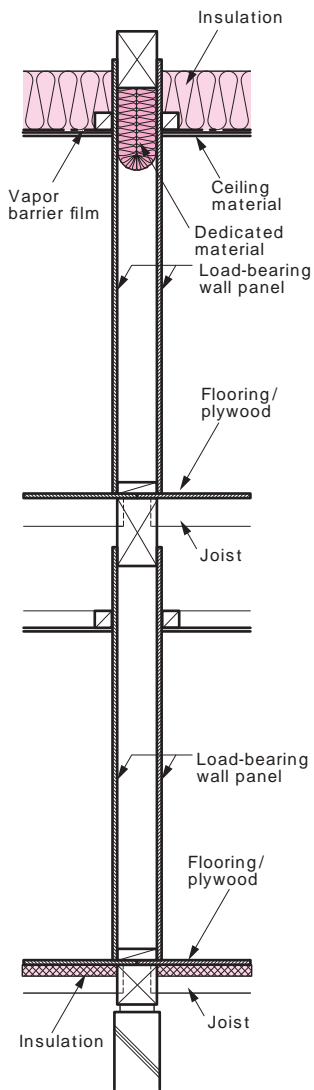

Fig. 29 Example of airflow blocking by Method 1

- Connections with attic (ceiling)  
(Airflow blocking by load-bearing wall panel)
- Connections with floor  
(Airflow blocking by subfloor plywood)

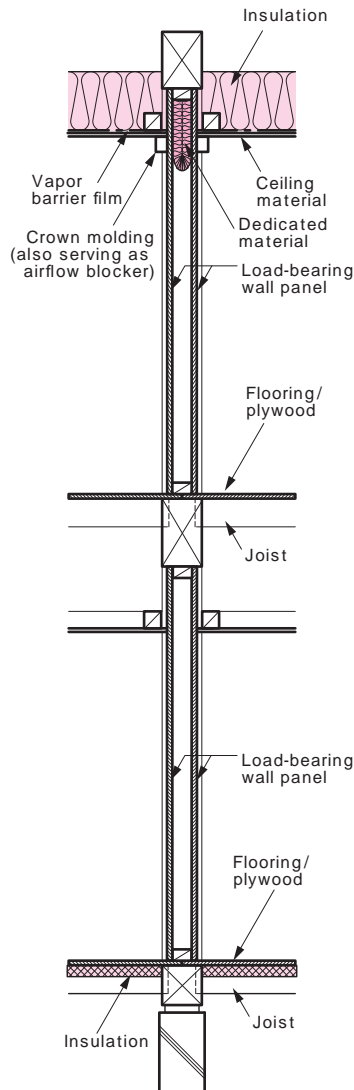

Fig. 30 Example of airflow blocking by Method 1

- Connections with attic (ceiling)  
(Airflow blocking by load-bearing wall panel)
- Connections with floor  
(Airflow blocking by subfloor plywood)

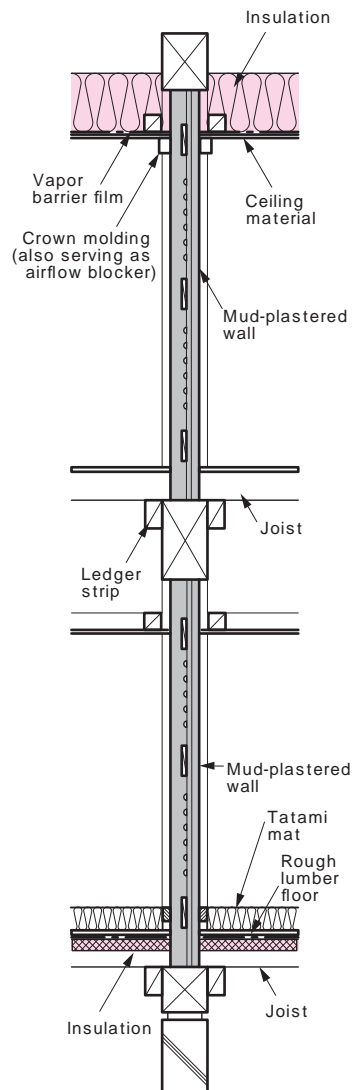

Fig. 31 Example of mud-plastered wall

- Mud-plastered walls structurally block airflow.

# 4

## Chapter 4 Heat Control Technology of Building Envelopes (Elemental Technology Application Method 2)

### 4) Installing insulation

Insulation should be installed ensuring that there is no gap (insulation deficiency) between it and the surrounding wood frame. When using insulation with an integral vapor barrier, sealed batt insulation that has large tabs is recommended (Fig. 32).

Generally, the minimum thickness of a separate vapor barrier film is 0.1 mm. Additionally, it is recommended that an integral vapor barrier should have the minimum thickness of 0.05 mm. When using either of these vapor barrier films, make sure to use the one that meets JIS A 6930 (Plastic films vapour barrier for residential use) to ensure long-term durability.

Fig. 32  
Sealed batt  
insulation having  
vapor barrier  
film with large  
tabs



Product example



Installation example

### 5) Examining insulation method for each component

#### Floor insulation

- Select insulation materials which do not cause harmful sagging, displacement or gaps between them and flooring after installation due to their own weight and drying shrinkage of wood, or install an insulation support that prevents sagging after installation.
- Perform moisture control for the ground under the floor and take underfloor ventilation measures including underfloor air vents.
- Installing subfloor plywood will ensure moisture control and air tightness.
- If Level 3 or 4 insulation is desired, either of the following moisture control measures is required:

If plywood is installed : Joints (seams) of plywood floor should be placed above the sheathing (floor joists, etc.) and the four corners of plywood floor should be nailed. If joining plywood without sheathing, seal the joints with airtight tape.

If plywood is not installed : Install an air and vapor barrier with a separate vapor barrier film unless tongue and groove flooring is used.

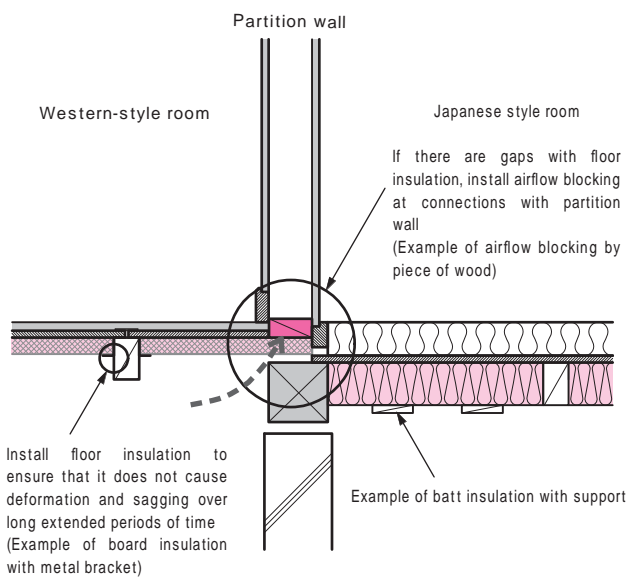

Fig. 33 Floor insulation

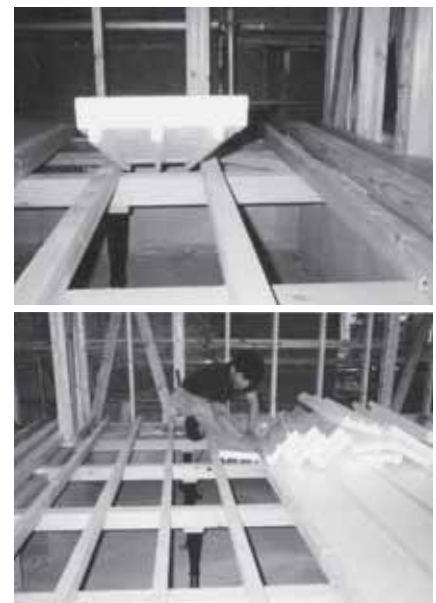

Fig. 34 Installation of board insulation



### Foundation insulation

- Insulation should be installed on the exterior, interior or both sides of the foundation. Insulation materials with low water absorption, such as plastic board insulation, should be used.
- In the case of foundation insulation, make sure to prevent gaps by installing airtight gasket between the upper surface of foundation and groundsill since the crawl space is used as the interior space. Underfloor air vent that is connected to the outside air is unnecessary. If directly fastening plywood floor to the groundsill, floor air vents should be installed in order to create a similar temperature and humidity environment in both indoor rooms and crawl space. Using decay and termite resistant wood for floor framing and slab on grade foundation for moisture control of the ground can eliminate the need for chemical preservatives in the crawl space (Fig. 35).
- Bathroom insulation is important in terms of energy conservation and occupant health. As it is difficult to insulate bathroom floors, foundation insulation is recommended instead (Fig. 36).

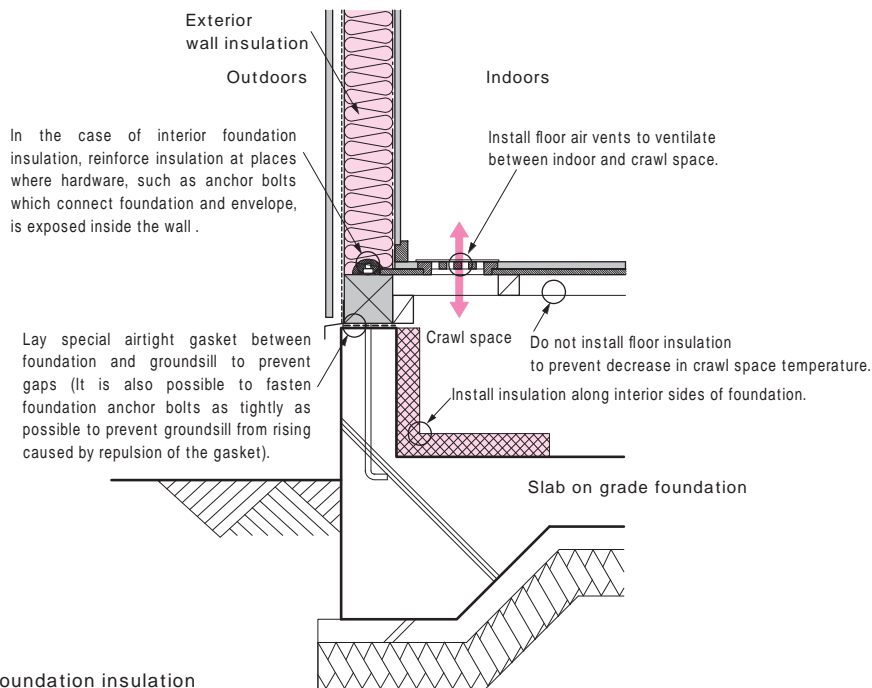

Fig. 35 Foundation insulation

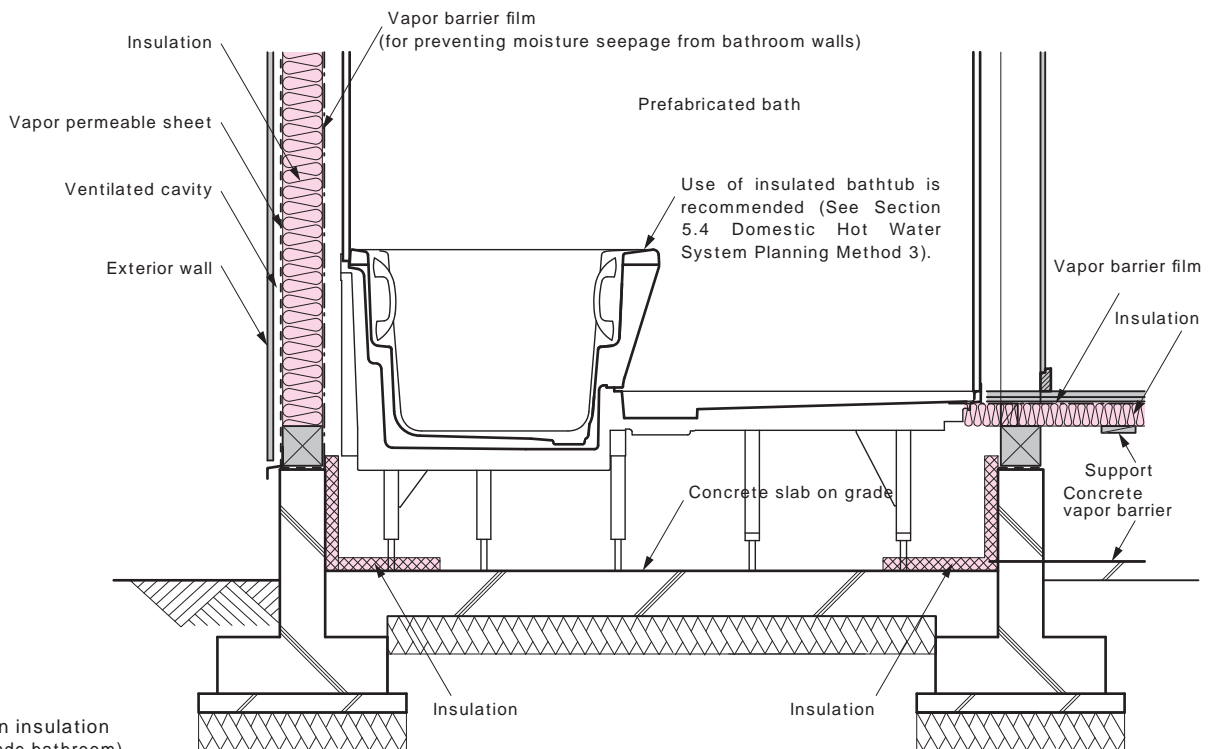

Fig. 36 Foundation insulation (slab on grade bathroom)

# 4

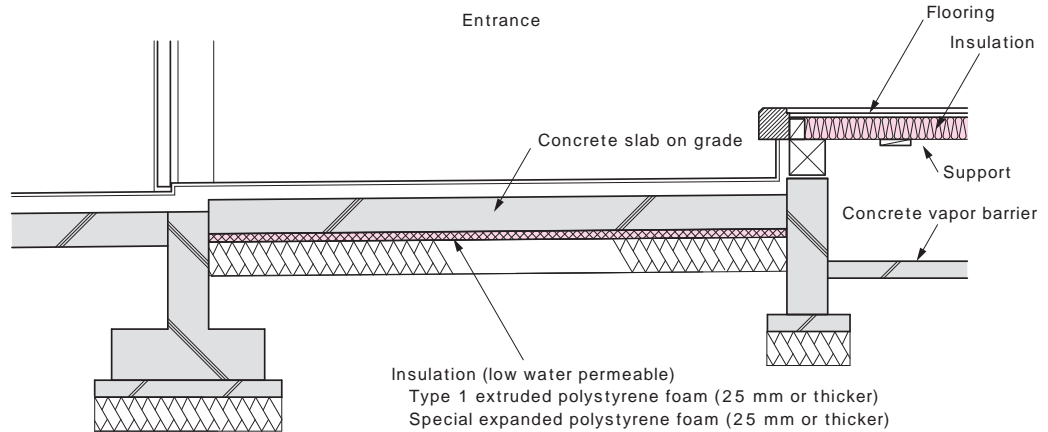

Fig. 37 Slab on grade insulation

## Exterior wall insulation

- Install airflow blocking along the top and bottom of the exterior walls.
- Lay insulation from the groundsill to the cross beam by ensuring that there will be no displacement or sagging over extended periods of time.
- Install insulation by ensuring that there is no gap between the diagonal brace and the piping.
- When using plastic board insulation, choose elastic insulation materials as much as possible and fill in the gaps.
- It is recommended to install a 15 – 20 mm thick ventilated cavity on the exterior side of the thermal barrier. The ventilated cavity prevents internal condensation in walls by removing moisture, eliminates water leakage from exterior finish, and expels heat in summer. When using a vapor permeable sheet for the weather barrier, make sure that sheathing is not covering the ventilated cavity.
- The following moisture control measures should be taken according to the target level:

Level 1, 2 : When using glass wool and other fiber batt insulation, choose the one that has a vapor barrier film attached to it and overlay and staple both tabs to pillars or studs. If the insulation does not have top and bottom tabs, create tabs as shown in Fig. 39 and fasten them to the cross beams, girth, groundsill and other components.

Level 3, 4 : When using glass wool or other fiber batt insulation that has a vapor barrier film attached to it, choose the one that has a solid vapor barrier film with wide tabs. Overlay both tabs at the wood sheathing and staple the four corners. If not using insulation with an integral vapor barrier, you need to control moisture using a separate vapor barrier film. When installing a vapor barrier film without an overlap at the ends, sandwich the ends between the sheathing and the vapor barrier film bracing.

- In the case of the exterior insulation, the installation of a ventilated cavity is recommended, as with interior insulation. When using plastic board insulation, seal the joints with airtight tape or lay weather barrier material (vapor permeable sheet).
- Mud-plastered wall does not require interior moisture control because of its high moisture capacity.

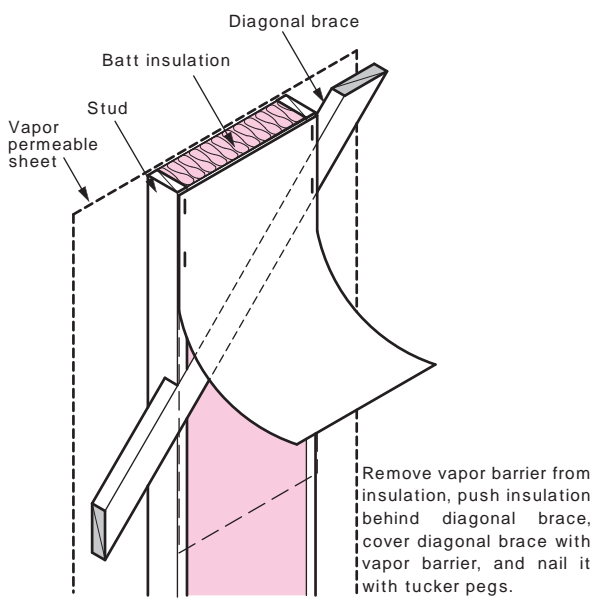

Fig. 38 Exterior wall insulation (insulation material with vapor barrier on load-carrying wall with diagonal brace)

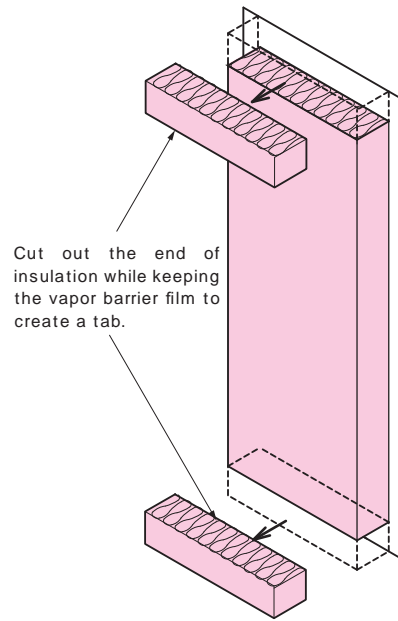

Fig. 39 Exterior wall insulation (installation of insulation material without tab)

### Ceiling insulation

- Insulation on the ceiling is prone to gaps at the connections between the ceiling and exterior walls, junctions with partition walls, areas around ceiling hangers, and between insulation materials. Install insulation over the entire ceiling seamlessly with the wall to prevent a gap.
- When using batt insulation over standard ceiling sheathing, lay insulation in parallel to the ceiling joist seats and install without any gaps by making slits in the ceiling hangers (Fig. 40). For moisture control measures, apply a separate vapor barrier film or use special plasterboard backed with a vapor barrier.

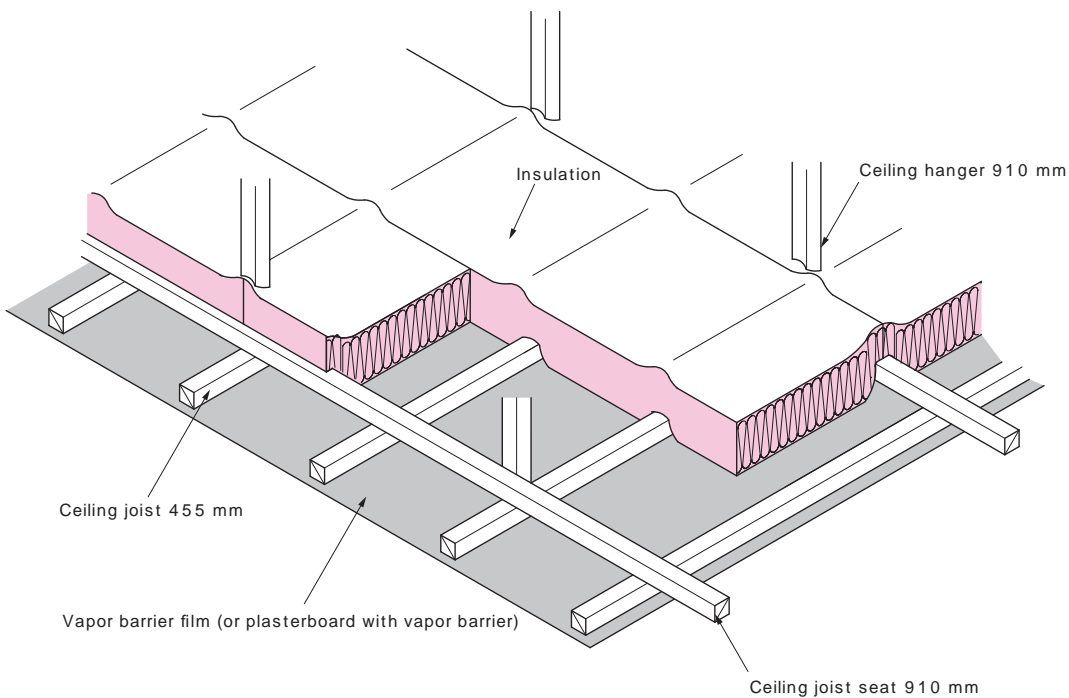

Fig. 40 Ceiling insulation 1

# 4

Chapter 4  
Heat Control Technology of  
Building Envelopes  
(Elemental Technology  
Application Method 2)

- When using insulation with an integral vapor barrier, insert insulation between the ceiling joists and staple the overlaid tabs of the vapor barrier at the bottom surface of the ceiling joists. If insulation thickness of at least 150 mm is required, use two layers of insulation and lay the top layer in parallel to the ceiling joist seats then place the bottom layer between the ceiling joists under the ceiling joist seats and fasten the tabs (Fig. 41).
- It is also possible to adopt a suspended ceiling construction method so that insulation with an integral vapor barrier can be used (Fig. 42). This method reduces insulation deficiency.
- Since batt insulation often causes gaps, a blown-in insulation method (blowing method) is also recommended for ceiling insulation (Fig. 43).
- Proper attic ventilation must be ensured. If there is a possibility of ceiling insulation blocking the attic ventilation path when using blown-in insulation, install sheathing board where it is required (Fig. 43).

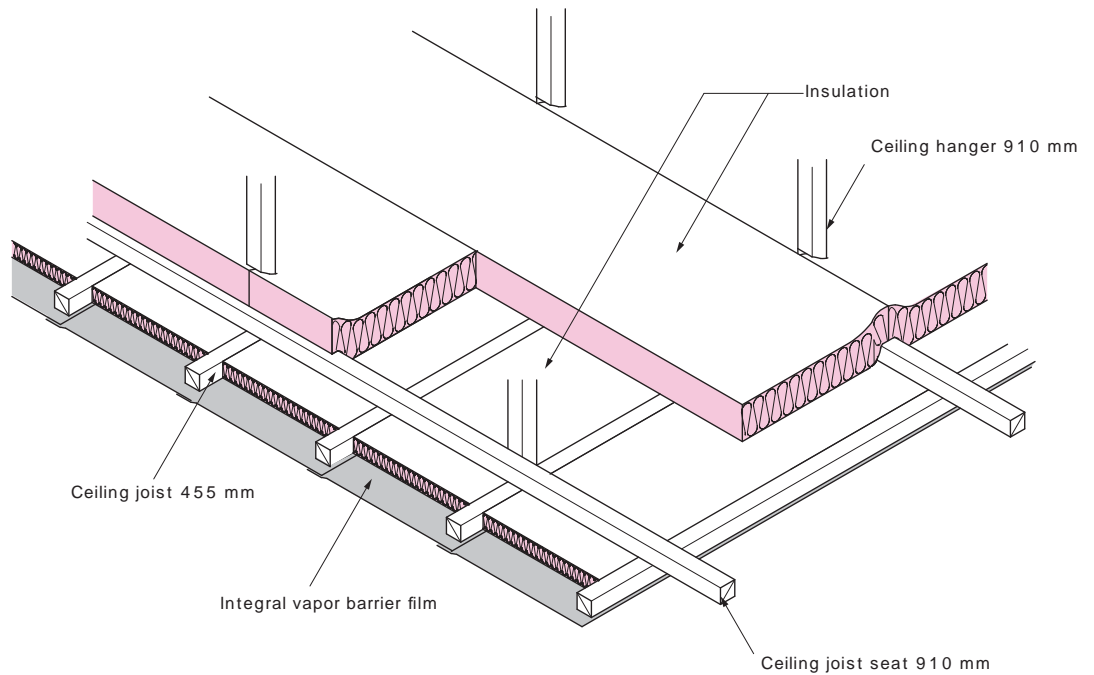

Fig. 41 Ceiling insulation 2

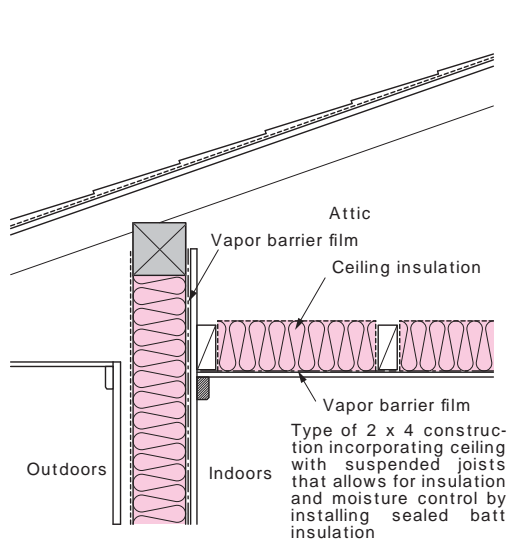

Fig. 42 Insulation of ceiling with suspended joists

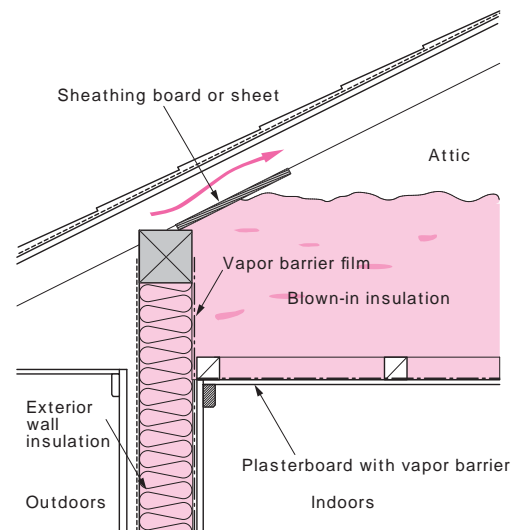

Fig. 43 Ceiling insulation by blowing method

### Insulation above beams

- Insulation above beams is one of the exterior insulation methods in which insulation is installed above plywood that is placed over the aligned tops of cross beams and tie beams. The advantages of this method include unlimited types and thickness of insulation, ease of installation and no need for airflow blocking in partition walls (Fig. 44).
- Regarding moisture control, the plywood serves as a vapor barrier.
- Proper attic ventilation must be ensured in the same way as ceiling insulation. If the house has a low pitch roof, install sheathing board where it is required in order to prevent ceiling insulation from blocking the attic ventilation path.

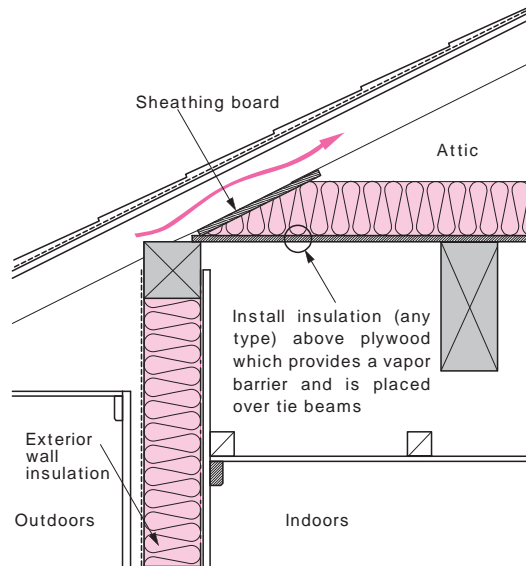

Fig. 44 Insulation above beams

### Roof insulation

- When applying roof insulation, installation of insulation and vapor barriers is the same as that for exterior walls.
- In order to prevent internal condensation and promote heat removal in summer, it is recommended to install a ventilated cavity with a thickness of at least 30 mm on the exterior side of the insulation. Particularly when using plastic board insulation (check heat resistance as it varies depending on the product type), the roof temperature becomes high and a proper ventilated cavity must be installed in order to prevent deterioration of insulation material (Fig. 45). However if the house has a tiled roof (no clay paste), there is a space between the roofing felt and tiles, and a ventilated cavity can be omitted.

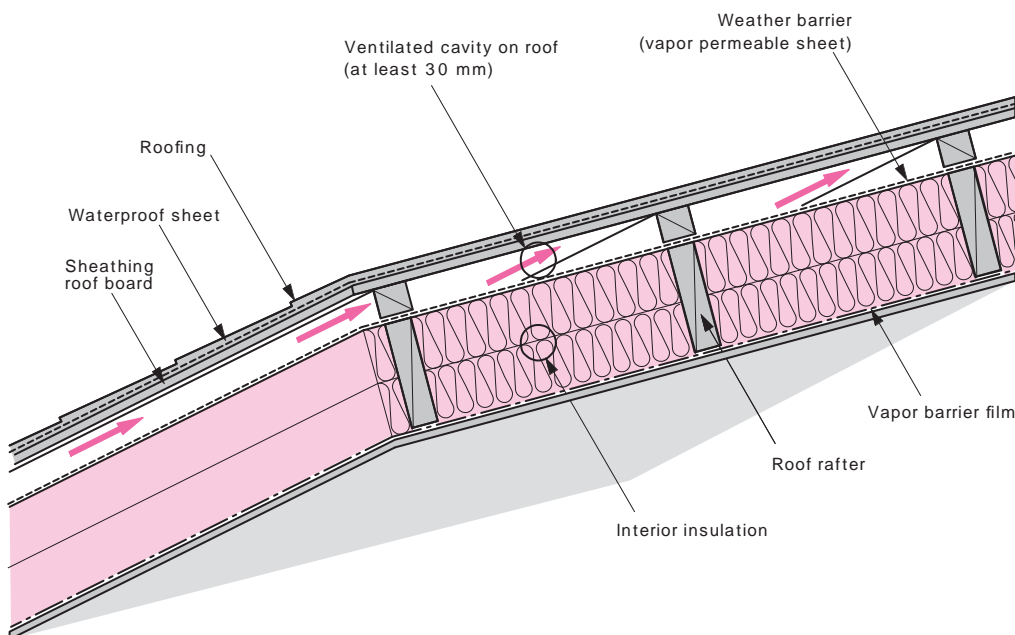

Fig. 45 Roof insulation

# 4

Chapter 4  
Heat Control Technology of  
Building Envelopes  
(Elemental Technology  
Application Method 2)

## Lean-to roof

- For a lean-to roof, since the hanging wall connected to the exterior wall of the upper floor is regarded as an exterior wall, install insulation with an integral vapor barrier as shown in Fig. 46.
- Airflow blocking is necessary in order to stop drafts from the attic of the lean-to roof from entering the area above the first floor ceiling.
- For airflow blocking, if Level 3 or 4 insulation is desired, fix a vapor barrier film with bracing as shown in the figure, or apply plywood or other sheet material to the same area and nail it at the four corners. If Level 1 or 2 insulation is desired, block airflow by making tabs that can be stapled at the four corners of the vapor barrier of the insulation with an integral vapor barrier.
- When insulating the ceiling of the attic of lean-to roof, use the same method as described in (v) Ceiling insulation.

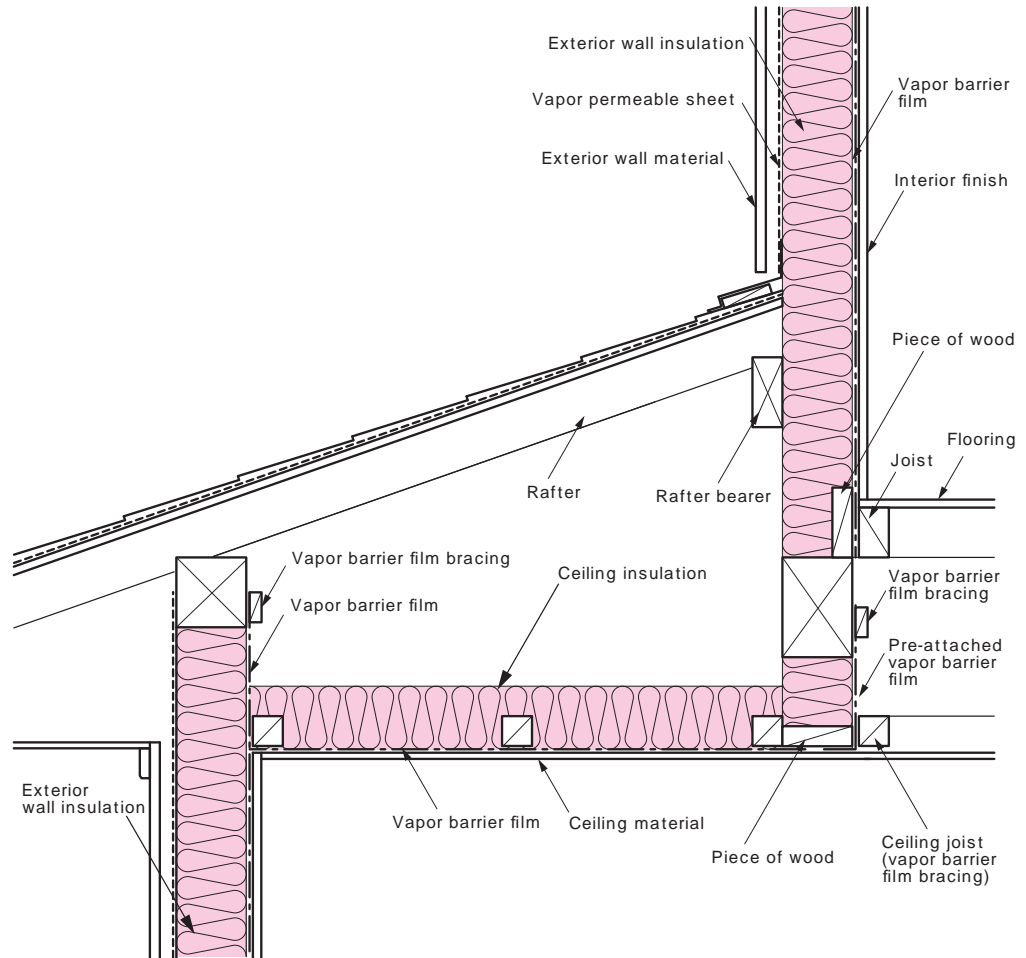

Fig. 46 Lean-to roof insulation

## 2 Examining insulation technology for openings

Openings such as window sashes and doors require functions that connect the indoors with the outdoors including heat, air, light and view, in addition to insulation performance and security as part of the building envelope. Among these required elements of openings, the insulation performance of openings is likely the weakness of the building envelope and it is important to choose the openings with appropriate performance of insulation materials according to the desired target level.

Table 6 Insulation performance of openings (heat transmission coefficient)

Frame structure	Typical heat transmission coefficient	
Frame specification	Glazing specification	( W/m <sup>2</sup> •K)
Single: Wooden or plastic	Low-E double glazing (A12)	2.33
	Triple Double glazing (A12 x 2)	2.33
	Double glazing (A12)	2.91
	Double glazing (A6)	3.49
Single: Metal/plastic (or wooden) composite structure	Low-E double glazing (A12)	2.33
	Low-E double glazing (A6)	3.49
	Double glazing (A10 A12)	3.49
	Double glazing (A6)	4.07
Single: Metal thermal break structure	Low-E double glazing (A12)	2.91
	Low-E double glazing (A6)	3.49
	Double glazing (A10 A12)	3.49
	Double glazing (A6)	4.07
Single: Metal	Low-E double glazing (A6)	4.07
	Double glazing (A6)	4.65
	Double glazing (at least A12)	4.07
	Double glazing (below A12)	4.65
	Single glazing	6.51

\* Numbers following A in parentheses: "A" as in (A12) indicated after double glazing, for example, stands for "Air" and the number after it indicates the thickness of air space between the glazing. A12 means an air space of 12 mm.

### 1) Selecting windows

Windows currently available in the market today include aluminum, resin, wood and their composite sash frames, and glazing comes in a wide variety such as double glazing, low-E double glazing and vacuum glazing. When designing and installing windows, it is necessary to consider construction areas, solar radiation level, sunshine hours, direction of the house, insulation performance and cost of windows, among other factors. Especially, the area of each window should be determined by taking into account the purposes and view of the room, thermal environment, light environment and cross ventilation performance. Table 7 summarizes the area of window and selection of glazing in terms of insulation performance of houses and solar radiation levels in winter. As the insulation performance of the house increases, so does the advantage of enlarging the openings.

Table 7 Selecting windows in terms of insulation performance of houses and solar radiation levels in winter

Regional characteristics	House with low insulation performance (Level 0) House with average insulation performance (Level 1)	House with high insulation performance (primarily Levels 2, 3, 4)
Region with high solar radiation level in winter	<ul style="list-style-type: none"> <li>Increased window area is effective in efficiently utilizing solar radiation heat.</li> <li>Use double glazing (3-A 12-3), low-E double glazing, etc. Insulating shutters can be used if needed.</li> </ul>	<ul style="list-style-type: none"> <li>Increased window area is highly effective in efficiently utilizing solar radiation heat.</li> <li>Use both double glazing (3-A 12-3) and insulating shutters for south-facing windows. For other directions, use low-E double glazing, etc.</li> </ul>
Region with low solar radiation level in winter	<ul style="list-style-type: none"> <li>Increased window area is less effective in efficiently utilizing solar radiation heat.</li> <li>Use double glazing (3-A 12-3), low-E double glazing, etc.</li> </ul>	<ul style="list-style-type: none"> <li>Increased window area is effective in efficiently utilizing solar radiation heat.</li> <li>Use low-E double glazing, etc.</li> </ul>

# 4

## 2) Selecting window sashes

Insulating sashes (metal frames with thermal break, resin sashes, wood sashes)

Since commonly used aluminum sashes have an extremely high thermal conductivity, condensation often occurs on the sash frames. Metal frames with thermal break (insulating sashes) divide the sash frames into the exterior and interior sides and connect them with rigid urethane and other materials that are less heat conductive. If aluminum sashes are desired, the use of metal frames with thermal break is recommended (Fig. 46). Moreover, resin or wood sashes with a low thermal conductivity have even higher insulation performance.

### Double glazing

Double glazing refers to two panes of glass filled with dry air or argon or other inert gas in the air space between the two panes, and has significantly higher insulation performance compared to single glazing (Fig. 47). Low-E double glazing and vacuum glazing are also available, which provide increased insulation performance through treated glass surfaces.

Double glazing has different specifications according to air space thickness. There are two types of double glazing that have the same thickness of glass, and the type having 12 mm air space is superior to the type having 6 mm air space in terms of insulation performance. It is recommended to select the double glazing with 12 mm air space, if possible, in order to ensure insulation performance.



Fig. 46  
Structure of  
metal frame  
with thermal  
break



Fig. 47  
Structure of  
double glaz-  
ing

## 3) Reinforced insulation by interior and exterior coverings

Normally, coverings are installed to the openings of the house, such as window screens and storm windows for the exterior and curtains and blinds for the interior of the windows. Even though little attempt has been made until recently to quantitatively estimate the effectiveness of these coverings in increasing insulation performance, an energy saving effect of nearly 10% has been confirmed.

## 4) Effectiveness of insulating shutters

Since openings have lower insulation performance than other housing components, the use of insulating shutters (insulating storm windows) dramatically increases comfort and energy efficiency (Fig. 48).

Interior insulating shutters require considerations in advance since they have some issues including condensation on the interior surface of the windows, heat warping of insulating shutters and their storage. In particular, as condensation leads to molds, taint damage or decay of building envelopes, it is important to consider controlling indoor humidity as well as air flow.

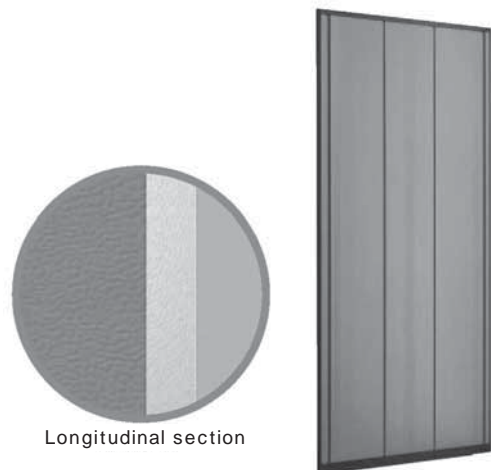

Fig. 48 Example of insulating shutter



## 4.1.6 Examples of Insulation Planning

Here, we will introduce examples of insulation planning for both partially reinforced insulation type and evenly distributed insulation type by target level. For the partially reinforced insulation type, planning examples of Level 3 insulation with different insulation methods for each component will be explained.

For the evenly distributed insulation type, we will show the planning examples of Level 1 to 3 insulation for average conventional timber frame houses and traditional mud-plastered timber frame houses. As previously mentioned, reinforcing insulation at the openings and ceilings will achieve the target level.

Even though no example of Level 4 insulation is given in this document, it is achievable if the insulation is further reinforced at the openings by increasing insulation performance of glazing and sash frames and incorporating insulating shutters based on the Level 3 insulation specifications.

Table 8 Correspondence between insulation level and insulation planning examples

Insulation level	Evenly distributed insulation type	Partially reinforced insulation type	
		Average conventional timber frame house	Traditional conventional timber frame house (mud-plastered wall)
Level 1	-	Example (1) Reinforced opening insulation	-
Level 2	-	Example (2) Reinforced ceiling and opening insulation	Example (4) Reinforced opening insulation
Level 3	Example (6) Interior insulation	Example (3) Reinforced ceiling and opening insulation	Example (5) Reinforced opening insulation
	Example (7) Insulation above beams and foundation insulation		
	Example (8) Exterior insulation		

Of the various methods explained on pp. 137-145, we will present examples of the typical airflow blocking methods by insulation level as shown below:

- Airflow blocking methods using primarily vapor barrier films (exterior walls) and dedicated materials (partition walls) have been provided as examples of planning Level 1 or 2 insulation.
- Airflow blocking methods using primarily vapor barrier films, bracing (exterior walls) and piece of wood (partition walls) have been provided as examples of planning Level 3 insulation.

# 4

Chapter 4  
Heat Control Technology of  
Building Envelopes  
(Elemental Technology  
Application Method 2)

## Insulation planning example (1): Level 1 Partially reinforced insulation type (openings)

- This specification conforms to the 1992 energy conservation standard.
- Compared to the specification of partially reinforced insulation type, this specification is characterized by the less strict wall insulation specification achieved by the reinforced insulation of openings.
- Connections circled in the figure below require airflow blocking in order to prevent cold air from entering inside the thermal barrier (other examples follow the same convention).

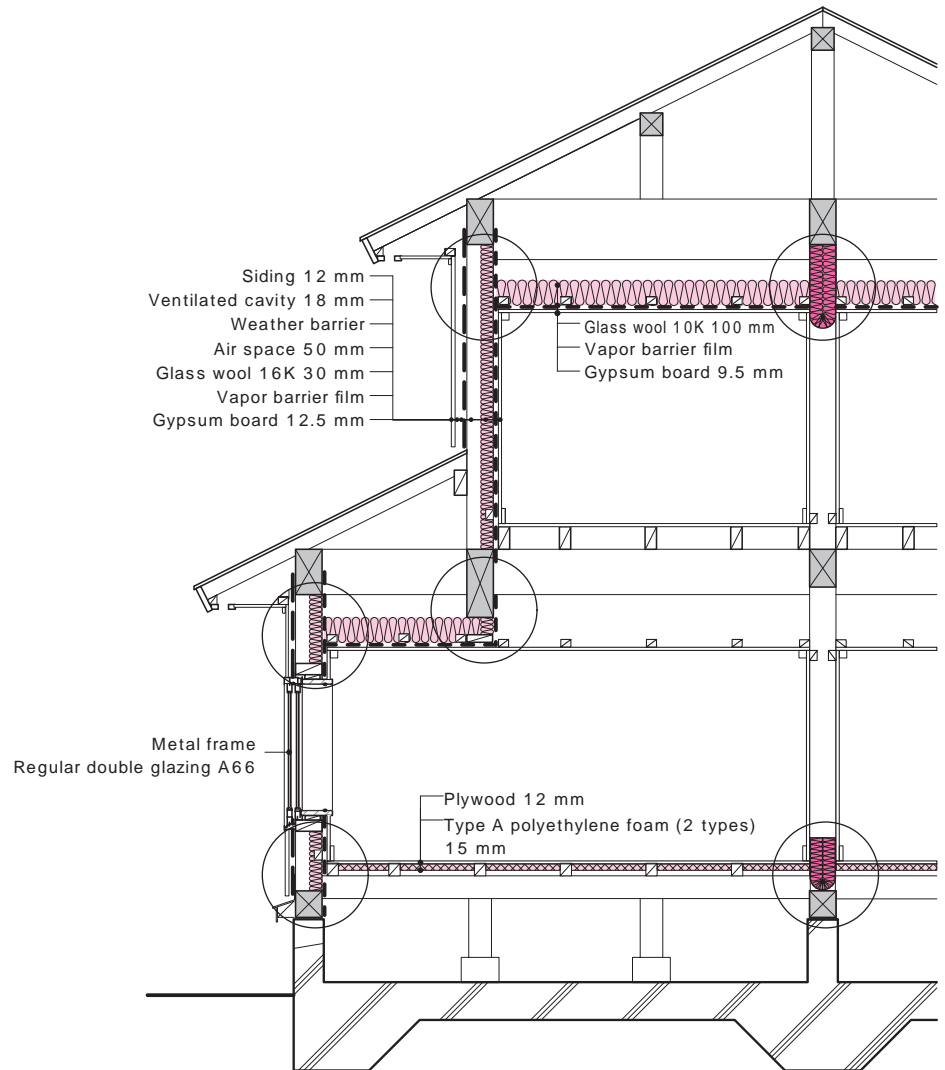

Cross-sectional detail

### Insulation specifications of components

Component	Insulation specification	Thermal resistance value (m <sup>2</sup> •K/W) (Heat transmission coefficient for opening)	1992 thermal resistance standard (m <sup>2</sup> •K/W) (Heat transmission coefficient for opening)
Roof/Ceiling	Glass wool 10K 100 mm	2.0	1.8 or above
Exterior wall	Glass wool 16K 30 mm	0.67	0.7 or above
Floor/Foundation	Type A polyethylene foam (2 types) 15 mm	0.39	0.5 or above
Opening	Double glazing with 6 mm air space	4.65 (heat transmission coefficient (W/m <sup>2</sup> •K))	6.51 (heat transmission coefficient (W/m <sup>2</sup> •K)) or below
Air change rate (winter air leakage)	Approx. 0.5 - 0.7 ACH*		1.0 ACH

\* Regarding insulation level achieved by combination of insulation and reinforced opening insulation, air tightness of the building envelope is expected to increase by installing airflow blocking to meet the 1992 standard level of insulation.

## Insulation planning example (2): Level 2 Partially reinforced insulation type (ceilings and openings)

- This specification conforms to the intermediate insulation level of the 1992 and 1999 energy conservation standards.
- In addition to the improved indoor thermal environment in winter, this specification is characterized mainly by the reinforced ceiling insulation that is aimed to increase summer heat protection performance in warm regions.

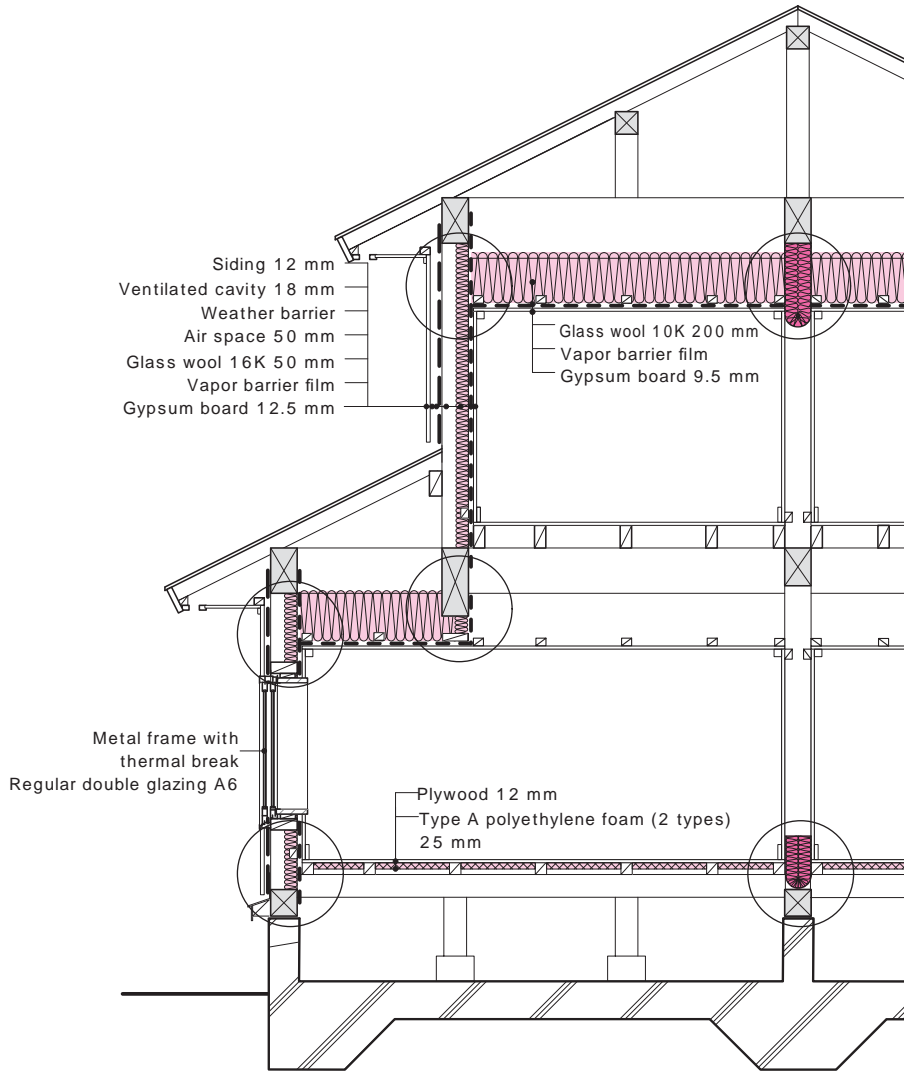

Cross-sectional detail

### Insulation specifications of components

Component	Insulation specification	Thermal resistance value ( $m^2 \cdot K/W$ ) (Heat transmission coefficient for opening)	1992 thermal resistance standard (Zone III) ( $m^2 \cdot K/W$ ) (Heat transmission coefficient for opening)
Roof/Ceiling	Glass wool 10K 200 mm	4.0	1.8 or above
Exterior wall	Glass wool 16K 50 mm	1.1	1.8 or above
Floor/Foundation	Type A polyethylene foam (2 types) 25 mm	0.65	1.8 or above
Opening	Double glazing with 6 mm air space + metal frame with thermal break	4.07 (heat transmission coefficient ( $W/m^2 \cdot K$ ))	4.65 (heat transmission coefficient ( $W/m^2 \cdot K$ )) or below
Air change rate (winter air leakage)	Approx. 0.5 - 0.7 ACH*		1.0 ACH

\* Regarding insulation level achieved by combination of insulation and reinforced opening insulation, air tightness of the building envelope is expected to increase by installing airflow blocking to meet the 1992 standard level of insulation.

# 4

Chapter 4  
Heat Control Technology of  
Building Envelopes  
(Elemental Technology  
Application Method 2)

## Insulation planning example (3): Level 3 Partially reinforced insulation type (ceilings and openings)

- This specification conforms to the 1999 energy conservation standard.
- In addition to the improved indoor thermal environment in winter, this specification provides reinforced insulation in ceilings (roof) and openings in order to increase summer heat protection performance in warm regions. On the other hand, it is characterized by the reduced insulation performance requirements in exterior walls and floors (foundation) and the simplified installation of these components.

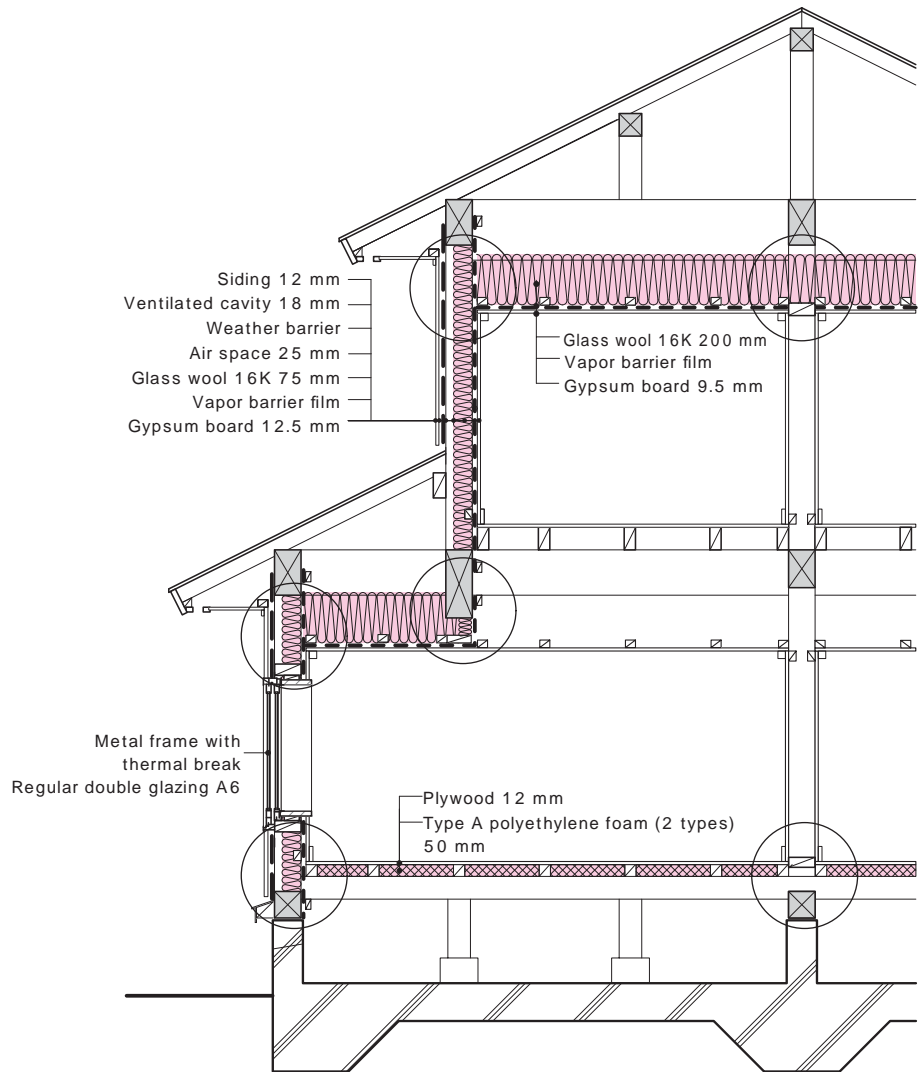

Cross-sectional detail

### Insulation specifications of components

Component	Insulation specification	Thermal resistance value ( $m^2 \cdot K/W$ ) (Heat transmission coefficient for opening)	1999 thermal resistance standard ( $m^2 \cdot K/W$ ) (Heat transmission coefficient for opening)
Roof/Ceiling	Glass wool 16K 200 mm	4.44	4.0 or above
Exterior wall	Glass wool 16K 75 mm	1.97	2.2 or above
Floor/Foundation	Type A polyethylene foam (2 types) 50 mm	1.31	2.2 or above
Opening	Double glazing with 6 mm air space + metal frame with thermal break	4.07 (heat transmission coefficient ( $W/m^2 \cdot K$ ))	4.65 (heat transmission coefficient ( $W/m^2 \cdot K$ )) or below
Air change rate (winter air leakage)	0.5 ACH		0.5 ACH

Insulation planning example (4): Level 2 Partially reinforced insulation type of mud-plastered house (openings)

- This specification conforms to the intermediate insulation level of the 1992 and 1999 energy conservation standards.
- For insulating exterior walls, an insulation material equivalent to at least 35 mm of 32K glass wool board is installed in the structural cavity on the exterior side of the mud-plastered walls.
- If there are any interior walls other than mud-plastered walls, it is important to install airflow blocking at the top and bottom of the walls as shown in the figure below.

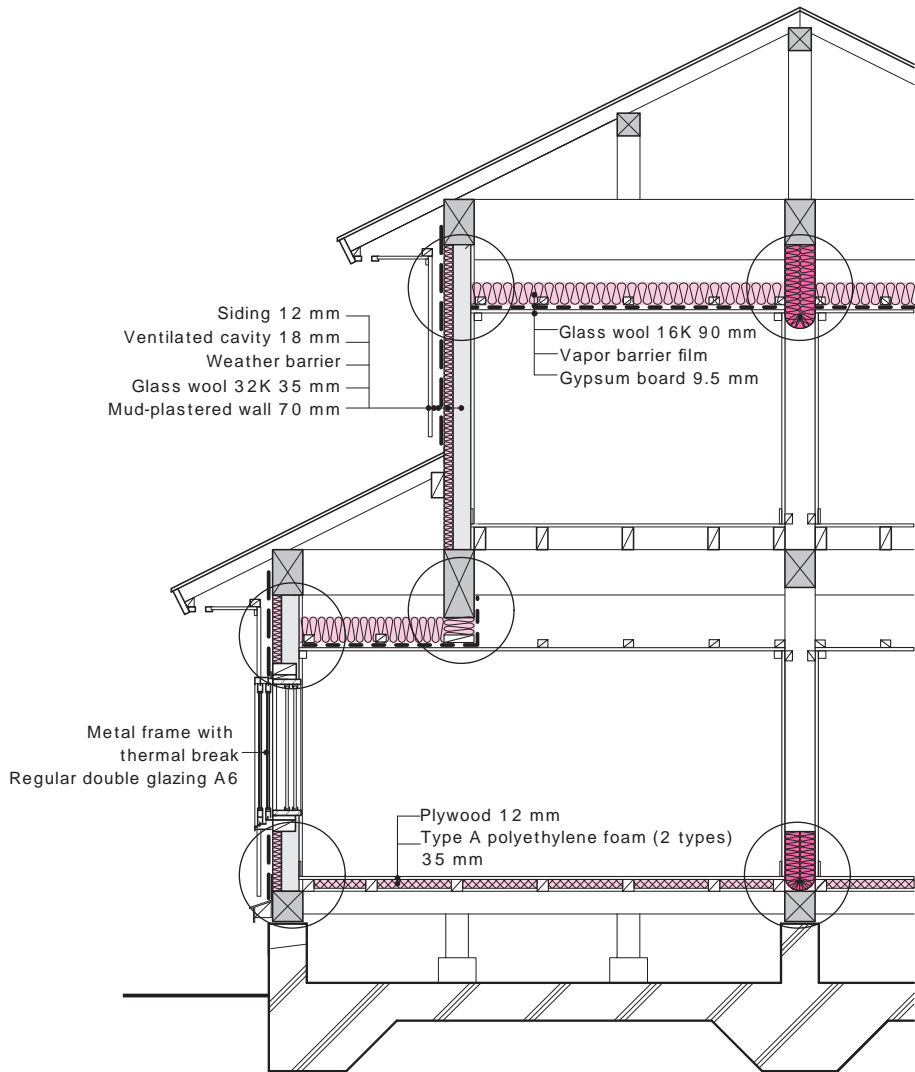

Cross-sectional detail

Insulation specifications of components

Component	Insulation specification	Thermal resistance value ( $m^2 \cdot K/W$ ) (Heat transmission coefficient for opening)	1992 thermal resistance standard (Zone III) ( $m^2 \cdot K/W$ ) (Heat transmission coefficient for opening)
Roof/Ceiling	Glass wool 16K 90 mm	2.0	1.8 or above
Exterior wall	Glass wool 32K 35 mm	0.97	1.8 or above
Floor/Foundation	Type A polyethylene foam (2 types) 35 mm	0.92	1.8 or above
Opening	Double glazing with 6 mm air space + metal frame with thermal break	4.07 (heat transmission coefficient ( $W/m^2 \cdot K$ ))	4.65 (heat transmission coefficient ( $W/m^2 \cdot K$ )) or below
Air change rate (winter air leakage)	Approx. 0.5 - 0.7 ACH*		1.0 ACH

\* Regarding insulation level achieved by combination of insulation and reinforced opening insulation, air tightness of the building envelope is expected to increase by installing airflow blocking to meet the 1992 standard level of insulation.

# 4

Chapter 4  
Heat Control Technology of  
Building Envelopes  
(Elemental Technology  
Application Method 2)

## Insulation planning example (5): Level 3 Partially reinforced insulation type of mud-plastered house (openings)

- This specification conforms to the 1999 energy conservation standards.
- For insulating exterior walls, an insulation material equivalent to at least 35 mm of 32K glass wool board is installed in the structural cavity on the exterior side of the mud-plastered walls.
- Insulation of openings is reinforced and insulating shutters are used at night.

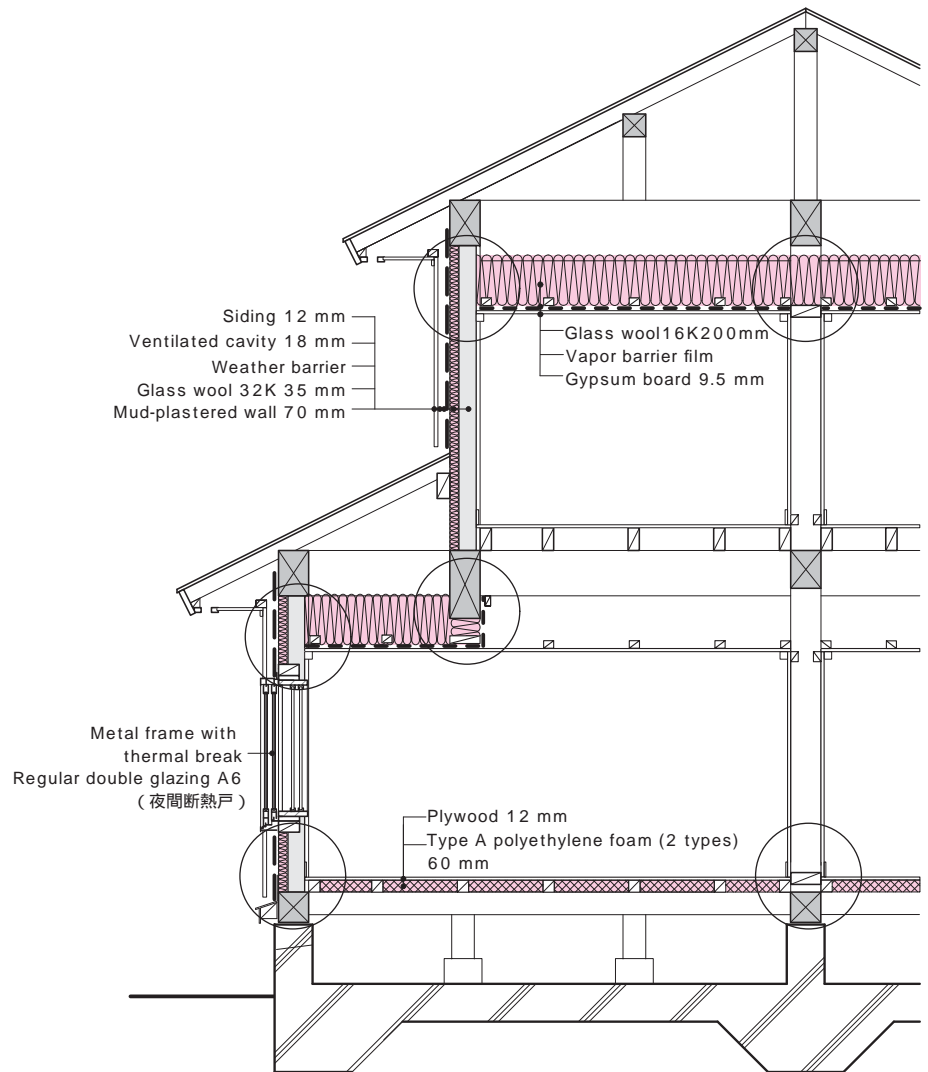

Cross-sectional detail

### Insulation specifications of components

Component	Insulation specification	Thermal resistance value ( $m^2 \cdot K/W$ ) (Heat transmission coefficient for opening)	1999 thermal resistance standard ( $m^2 \cdot K/W$ ) (Heat transmission coefficient for opening)
Roof/Ceiling	Glass wool 16K 200 mm	4.44	4.0 or above
Exterior wall	Glass wool 32K 35 mm	0.97	2.2 or above
Floor/Foundation	Type A polyethylene foam (2 types) 60 mm	2.2	2.2 or above
Opening	Double glazing with 6 mm air space + metal frame with thermal break + insulating shutter at night (thermal resistance (R value) = 0.36 or greater)	3.06 (heat transmission coefficient ( $W/m^2 \cdot K$ ))	4.65 (heat transmission coefficient ( $W/m^2 \cdot K$ )) or below
Air change rate (winter air leakage)	0.5 ACH		0.5 ACH

Insulation planning example (6): Level 3 Evenly distributed insulation type (interior insulation)

- This specification conforms to the 1999 energy conservation standard.
- This example uses the interior insulation method for all the ceilings, exterior walls and floors.

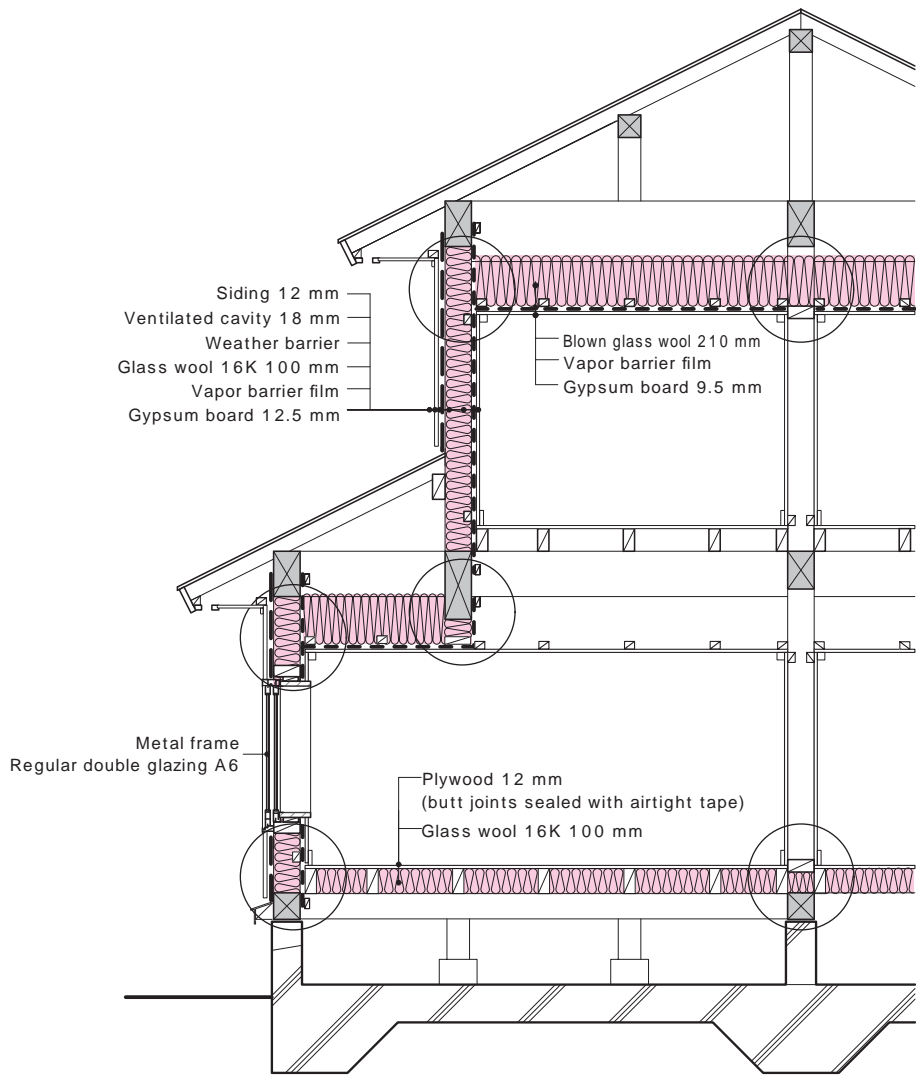

Cross-sectional detail

Insulation specifications of components

Component	Insulation specification	Thermal resistance value (m <sup>2</sup> •K/W) (Heat transmission coefficient for opening)	1999 thermal resistance standard (m <sup>2</sup> •K/W) (Heat transmission coefficient for opening)
Roof/Ceiling	Blown glass wool 16K 210 mm	4.0	4.0 or above
Exterior wall	Glass wool 16K 100 mm	2.2	2.2 or above
Floor/Foundation	Glass wool 16K 100 mm	2.2	2.2 or above
Opening	Double glazing with 6 mm air space	4.65 (heat transmission coefficient (W/m <sup>2</sup> •K))	4.65 (heat transmission coefficient (W/m <sup>2</sup> •K)) or below
Air change rate (winter air leakage)	0.5 ACH		0.5 ACH

Insulated Building Envelope Planning for Zone V 4.1

# 4

Chapter 4  
Heat Control Technology of  
Building Envelopes  
(Elemental Technology  
Application Method 2)

## Insulation planning example (7): Level 3 Evenly distributed insulation type (insulation above beams and foundation insulation)

- This specification conforms to the 1999 energy conservation standard.
- This example adopts insulation above beams for the ceilings, interior insulation for exterior walls, and foundation insulation for the floor area.
- Insulation above beams is not yet commonly practiced, but this method was developed to reduce insulation loss. As plywood is installed over tie beams and insulation is laid on it, there is very little gap between insulation and it is easy to install a vapor barrier.

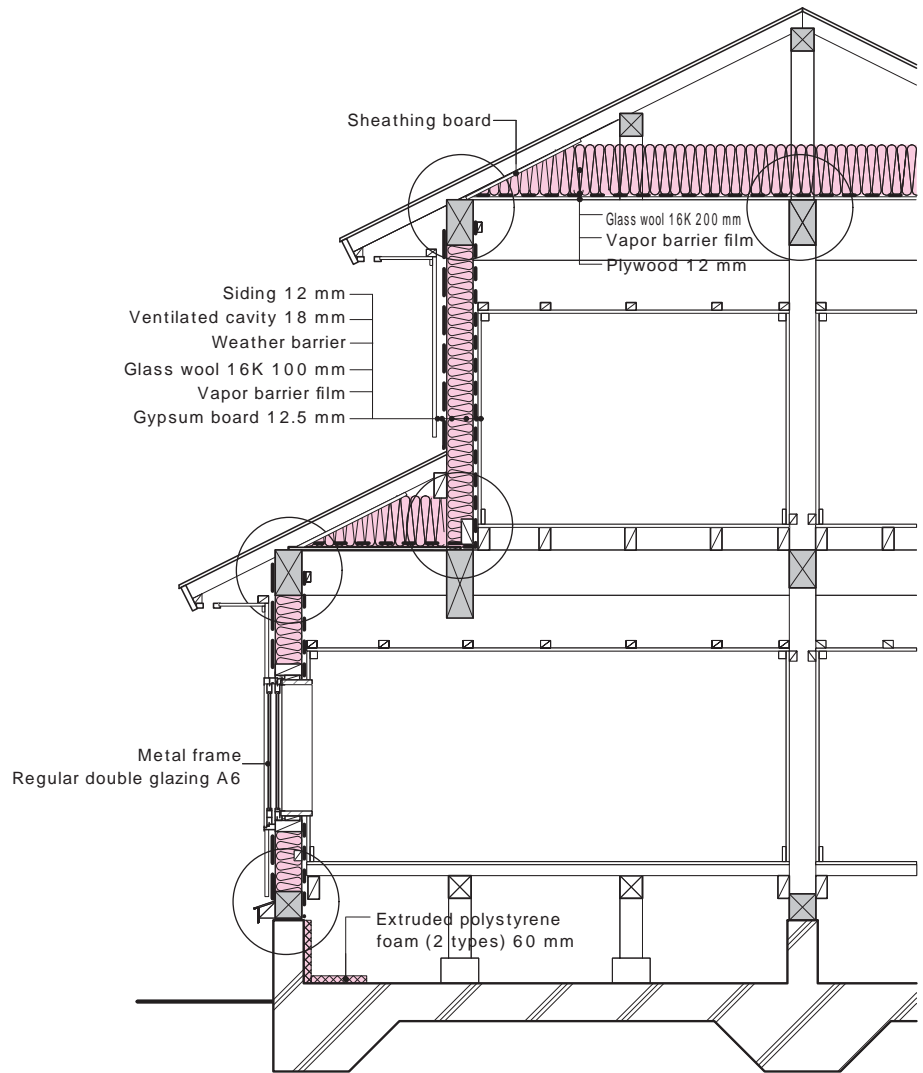

Cross-sectional detail

### Insulation specifications of components

Component	Insulation specification	Thermal resistance value ( $m^2 \cdot K/W$ ) (Heat transmission coefficient for opening)	1999 thermal resistance standard ( $m^2 \cdot K/W$ ) (Heat transmission coefficient for opening)
Roof/Ceiling	Glass wool 16K 200 mm	4.44	4.0 or above
Exterior wall	Glass wool 16K 100 mm	2.2	2.2 or above
Floor/Foundation	Extruded polystyrene foam (2 types) 60 mm	1.75	1.7 or above
Opening	Double glazing with 6 mm air space	4.65 (heat transmission coefficient ( $W/m^2 \cdot K$ ))	4.65 (heat transmission coefficient ( $W/m^2 \cdot K$ )) or below
Air change rate (winter air leakage)	0.5 ACH		0.5 ACH



## Insulation planning example (8): Level 3 Evenly distributed insulation type (exterior insulation)

- This specification conforms to the 1999 energy conservation standard.
- This example shows roof insulation, exterior insulation of exterior walls and foundation insulation.

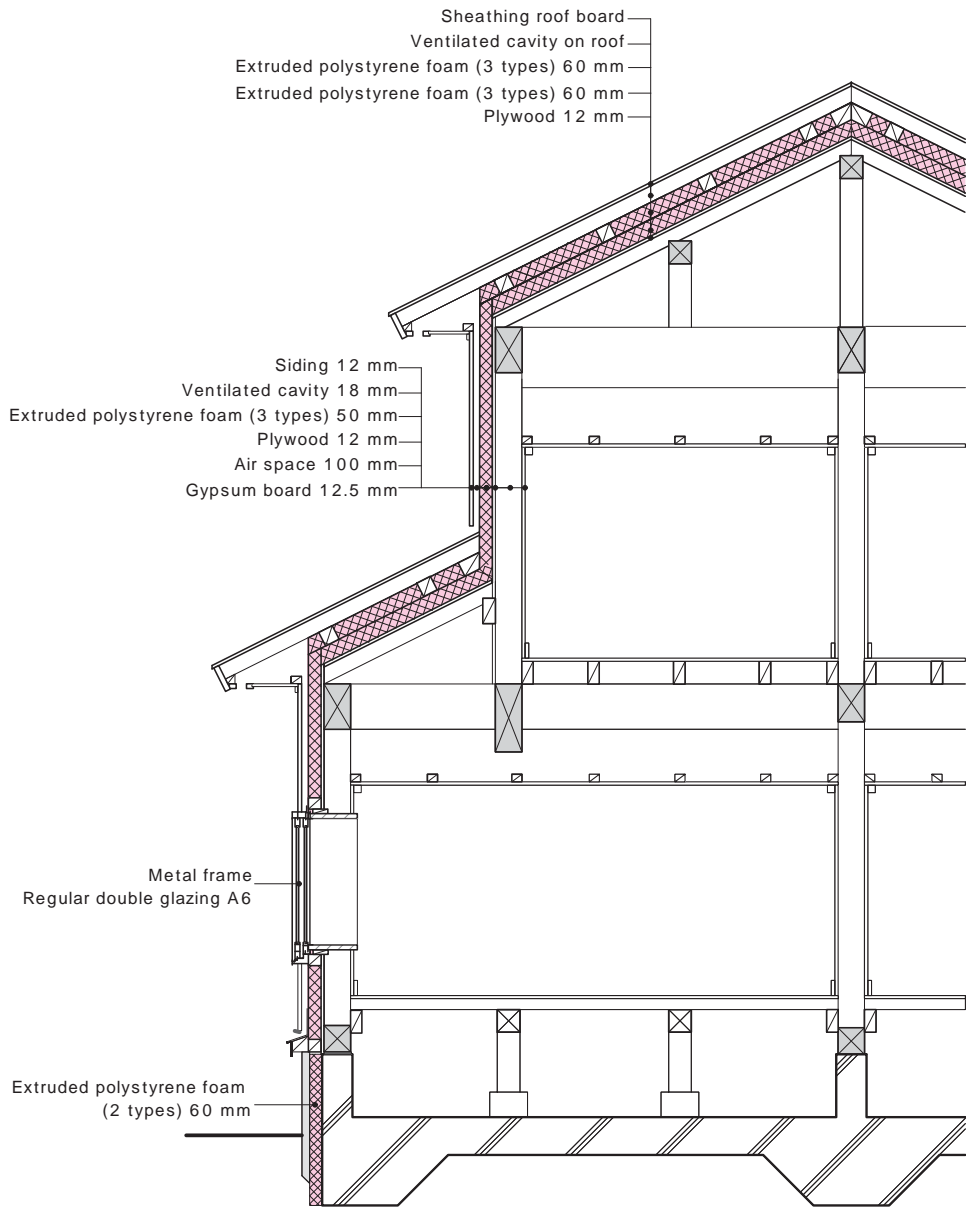

Cross-sectional detail

### Insulation specifications of components

Component	Insulation specification	Thermal resistance value ( $m^2 \cdot K/W$ ) (Heat transmission coefficient for opening)	1999 thermal resistance standard ( $m^2 \cdot K/W$ ) (Heat transmission coefficient for opening)
Roof/Ceiling	Extruded polystyrene foam (3 types) 60 mm x 2	4.2	4.0 or above
Exterior wall	Extruded polystyrene foam (3 types) 50 mm	1.7	2.2 or above
Floor/Foundation	Extruded polystyrene foam (2 types) 60 mm	1.75	2.2 or above
Opening	Double glazing with 6 mm air space	4.65 (heat transmission coefficient ( $W/m^2 \cdot K$ ))	4.65 (heat transmission coefficient ( $W/m^2 \cdot K$ )) or below
Air change rate (winter air leakage)	0.5 ACH		0.5 ACH

# 4

## 4.2 Solar Shading Methods for Zone VI

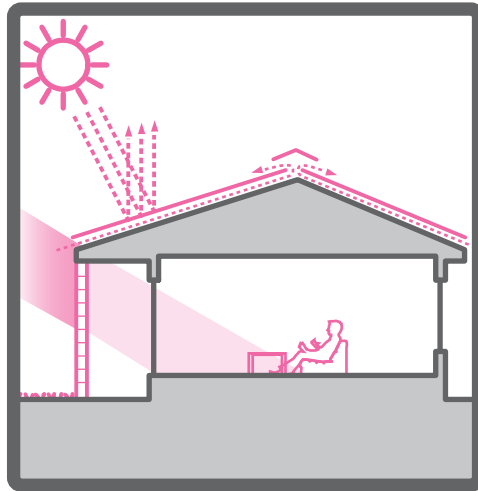

Of the hot humid regions, most of the year is spent using either cross ventilation or cooling in Zone VI (Okinawa Prefecture), and in order to reduce the amount of energy used for cooling and improve comfort, “solar shading”, which effectively shields solar radiation that would penetrate houses, is important.

Schemes for preventing solar penetration in temperate regions, which are not as hot as hot humid regions, focus on openings, but in Zone VI, it is also important to effectively use heat shielding on the roof or walls as well as the environment surrounding a building.

### 4.2.1 Purpose and Key Points of Solar Shading

#### 1. Reducing amount of energy used for cooling

- Solar radiation has a major effect on the thermal environment in a house. In summer and in-between seasons, there is a greater need to use cross ventilation and cooling to reduce the room temperature, which increases because of solar radiation heat, but as the amount of such heat entering a room (amount of solar radiation penetration) increases, the usability of cross ventilation is limited and the amount of energy used for cooling increases.
- One purpose of solar shielding is, as the expression suggests, to shade from solar radiation, thereby reducing the amount entering a building and cutting the amount of energy used for cooling. There is a much greater need for cooling than heating in hot humid regions, meaning that solar shading in order to reduce the amount of energy consumed is extremely important.

#### 2. Maintaining cool rooms

- In order to keep rooms cool in summer and in-between seasons, solar shading is important along with cross ventilation. In order to use solar shading efficiently, it is important to take into account the orientation of the components of the building envelope. By suppressing the amount of solar radiation entering rooms, it is possible to limit the increase in room temperature and also limit the surface temperature on the inside of the roof and exterior walls.

#### Key Point

Basic matters that are background knowledge for examining solar shading schemes

#### (1) Direct solar radiation and diffuse solar radiation

- Solar radiation includes direct solar radiation, which is incident directly from the sun, and diffuse solar radiation, which is incident after being diffused the atmosphere, clouds and the like (Fig. a). When the weather is good, the amount of direct solar radiation is high and the amount of diffuse

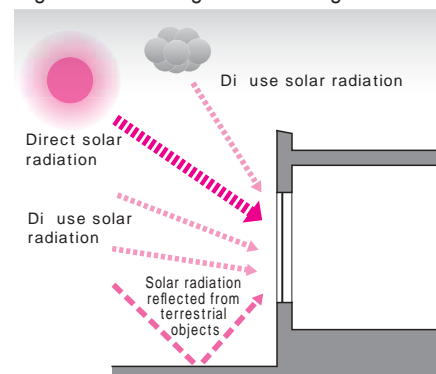

Fig. a Direct solar radiation and diffuse solar radiation

solar radiation is low. In addition, the amount of solar radiation which is incident after being reflected from the ground and other outside surfaces cannot be ignored.

(2) Differences in the amount of solar radiation due to orientation

- The amount of solar radiation striking a building differs depending on the season and the orientation of the components of the building (Fig. b). The amount of solar

Fig. b  
Global solar radiation level received by horizontal surfaces and exterior walls (Average values for May, Aug. and Jan. in Naha)

- Horizontal surfaces
- East-facing vertical surfaces
- ◆ South-facing vertical surfaces
- West-facing vertical surfaces
- ▲ North-facing vertical surfaces
- Air temperature

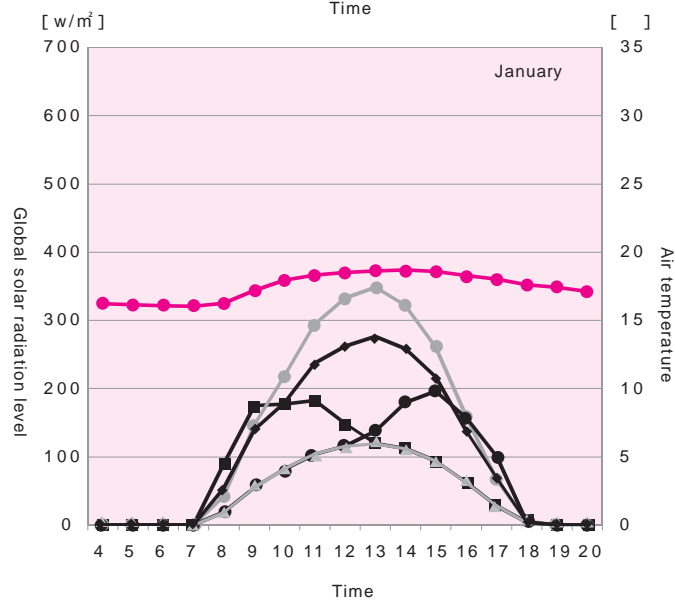
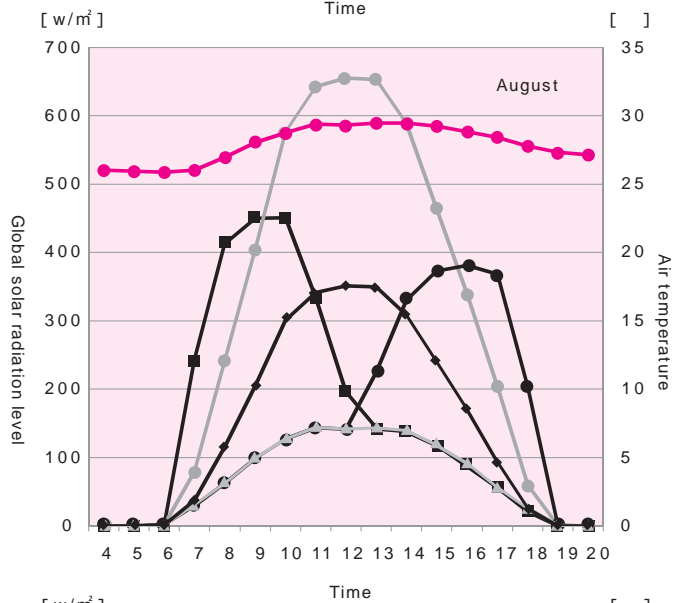
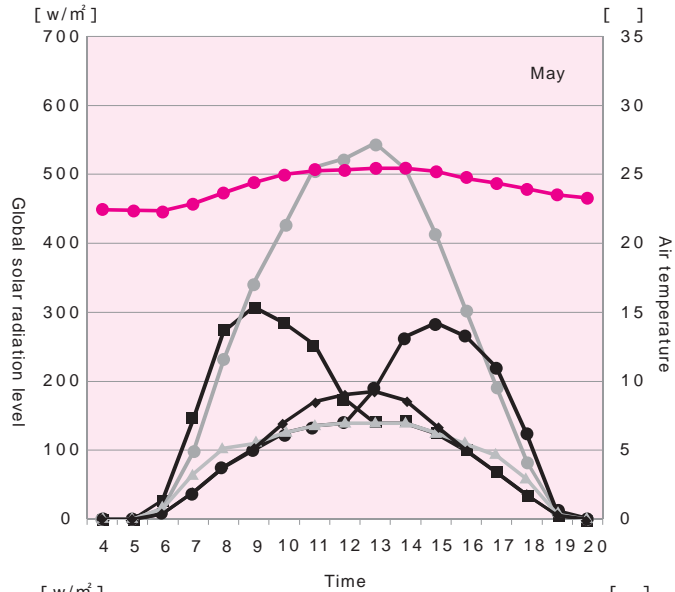

# 4

## Chapter 4 Heat Control Technology of Building Envelopes (Elemental Technology Application Method 2)

**Glossary: Solar penetration rate**  
The solar penetration rate is the proportion of heat that enters a room relative to the amount of incident solar radiation heat, and is also known as the solar heat gain coefficient. As this value decreases, the solar shading performance increases.

radiation in the summer, when the solar altitude is high in the sky, increases greatly on horizontal surfaces such as roofs, but for vertical walls, windows, etc., the amount of incident solar radiation is larger on east- or west-facing surfaces and smaller on south-facing surfaces. Understanding this characteristic of solar radiation is the key for effective solar shading schemes.

(3) Differences in the amount of transmitted solar radiation due to transparent and non-transparent components

- As shown in Fig. c, solar radiation levels from transparent components such as windows is far greater than from non-transparent components such as roofs or exterior walls. Therefore, transparent components such as windows are important for achieving adequate solar shading schemes.
- In addition, the effect of external shading, which shades solar radiation on the outside, is greater than that of internal shading, which shades solar radiation inside openings. In hot humid regions in particular, effective external shading is achieved by *amahaji* and blocks with decorative openings.
- For non-transparent components such as roofs, solar shading schemes are firstly to increase the solar radiation reflectance, to provide a ventilated cavity which insulates from the heat and ventilates well, and to enable attic ventilation.

Fig c  
Comparison of the  
solar penetration rates  
of windows and roofs

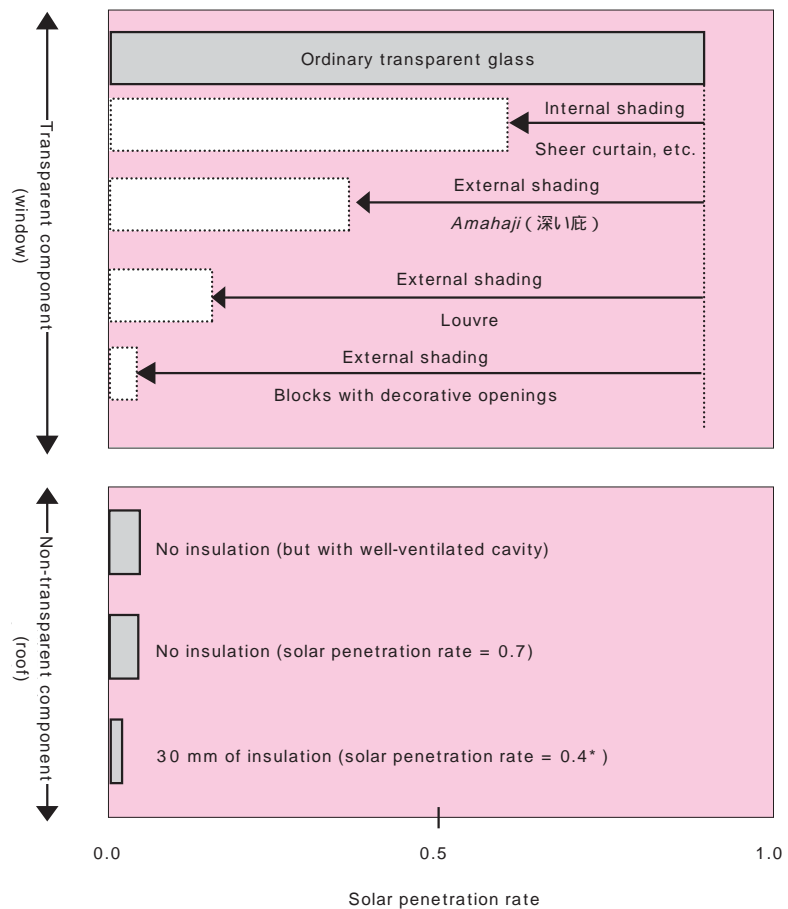

\* From this diagram, it can be seen that insulation has a significant effect on reducing the solar penetration rate, but insulating performance is not necessarily the best way of reducing the cooling load and the amount of energy used for cooling since heat radiation via the building envelope when the air temperature is lower, such as at night, is also an important factor.

Note: Fig. c shows the proportion of solar penetration per unit area. Solar shading schemes in windows and roofs are important, and with typical house layouts, it is also useful to consider the area weighting for both these components, which is approximately 1:4.

## 4.2.2 Energy Conservation Target Levels for Solar Shading Schemes

### 1. Definition of target levels

- Energy conservation target levels for solar shading schemes have been set at levels 1-4 below and indicate the reduction rate of energy consumed by cooling systems (Table 1).
- The cooling energy reduction rate is closely related to the summer solar gain coefficient, which takes into account the effect of adjacent buildings and other factors (hereafter referred to as the “M value”), and by reducing the M value, the cooling energy reduction effect increases.
- The M value is a numerical value determined by the following design conditions and specifications of houses, A-C, and corresponds to the ratio of the solar radiation heat that penetrates the inside of a house, in relation to the global solar radiation incident upon a horizontal surface equivalent to the area of the total floor surface of the house.
  - A. Site conditions (related to orientation, adjacent buildings, etc.)
  - B. Outside shading devices – presence/absence of components such as overhangs attached to the building (Method 1)
  - C. Envelope solar shading schemes – schemes for ensuring solar radiation reflection, cavity ventilation, and insulation on the building envelope, particularly the roof (Method 2)
- The relationship between the M value and the cooling energy consumption differs depending on the type of envelope (roof) solar shading schemes.
- Increasing the solar radiation reflectance of the roof achieves a better effect for an equivalent M value than providing cavity ventilation or insulation schemes (See p.173). Please confirm the M values that can achieve the target levels for each roof solar shading scheme used and then consider solar shading schemes that enable M values smaller than these.

Table 1 Target levels for solar shading schemes and how to achieve them

Target level	Energy conservation effect (Cooling energy reduction rate)	M value	
		Roof solar shading schemes by ventilated cavity or insulation	Roof solar shading schemes by solar radiation reflection
Level 0	No reduction	> 0.135	> 0.150
Level 1	10% reduction	≤ 0.135	≤ 0.150
Level 2	20% reduction	≤ 0.10	≤ 0.125
Level 3	25% reduction	≤ 0.08	≤ 0.115
Level 4	30% reduction	≤ 0.065	≤ 0.105

- The standard cooling energy consumption as of 2000 was 10.3 GJ (approximately 16% of overall energy consumption) (See 6.1 on p.339).
- Level 0 assumes a house having no solar shading schemes, that is, located at a site where there are no adjacent buildings to shade the solar radiation, employing no outside shading devices such as overhangs, and lacking any particular envelope solar shading scheme. By combining conditions and specifications A-C above, it is possible to reduce the cooling energy by a maximum of approximately 30%.

#### Key Point

#### What is the M value ?

The summer solar gain coefficient that takes into account the effect of adjacent buildings and other objects is based on the standard “summer solar gain coefficient”, which is used in the 1999 Energy Conservation Standards, and is an indicator of solar shading performance, which is newly defined in this document. The conventional summer solar gain coefficient indicates the average ratio during the cooling period of the amount of solar radiation heat actually gained by the inside of a building to the solar radiation heat level able to be gained by assuming that there is no shading by the building. The effects of shading objects such as other buildings around the building in question, the solar radiation reflectance of the surface of exterior finishing materials, and

# 4

**Glossary: Exposure factor**  
The exposure factor indicates the ratio of the amount of solar radiation incident upon vertical surfaces (exterior walls), having the same area but facing in different directions, when considering the amount of solar radiation incident upon a horizontal surface having no shading objects around it as 1.

ventilated cavities on the outside of the building envelope, however, were generally not taken into account in the calculations. By considering factors such as these, the summer solar gain coefficient that takes into account the effect of adjacent buildings and other objects is an indicator that aims to include the effects of a wider range of solar shading schemes. The conventional summer solar gain coefficient is known as the  $\mu$  value, but in order to avoid confusion, the summer solar gain coefficient that takes into account the effect of adjacent buildings and other objects is known as the M value.

## 2. Requirements for achieving target levels

Target levels are determined by M values, as mentioned above. However, because the calculations for obtaining these M values are quite complex, we have given examples of the site conditions, outside shading devices (Method 1) and building envelope solar shading schemes (Method 2) involved in determining M values in this document, and have made it possible to confirm whether or not the target levels can be achieved through the selection of these conditions and specifications.

We will clarify the methods for calculating and judging M values and the methods for calculating cooling loads from M values in this chapter.

### 1) Site conditions (solar shading by adjacent buildings and other objects)

- Solar radiation that strikes the exterior walls of a house is sometimes shaded by buildings and other objects surrounding the house (including adjacent buildings). In other words, even if the solar radiation is the same, the effect of the solar radiation incident upon a house can differ depending on the distance to adjacent buildings, the number of floors in adjacent buildings, surrounding vegetation and other objects.
- The effect of solar shielding by adjacent buildings and other objects is expressed by the exposure factor. The smaller the exposure factor, the higher the solar shading effect.
- In this document, we have set up three typical site categories, sites 1-3, which differ in terms of horizontal distance to adjacent buildings and other objects (Table 2). The susceptibility to the effects of solar radiation increases in the order of Site 1, Site 2 and Site 3.

Site 1: Site in which adjacent buildings and other objects are close, such as in large cities

Site 2: Site in which adjacent buildings and other objects are fairly close, such as in suburbs near cities

Site 3: Site in which adjacent buildings and other objects are not close, such as in suburbs away from city centers

Table 2 Requirements and exposure factors for site categories (Naha, Mar. 25 Dec. 14)

Site category	Orientation	Horizontal distance to adjacent buildings and other objects	Exposure factor
Site 1	North	6 m or less	0.31
	East	3 m or less	0.26
	South	6 m or less	0.41
	West	3 m or less	0.32
Site 2	North	6 - 10 m	0.34
	East	3 - 10 m	0.35
	South	6 - 10 m	0.44
	West	3 - 10 m	0.42
Site 3	North	More than 10 m	0.39
	East	More than 10 m	0.39
	South	More than 10 m	0.49
	West	More than 10 m	0.47
Horizontal surface			1.00

- Table 2 shows the horizontal distance to adjacent buildings and other objects in the directions north, east, south and west, which are the conditions for each site, and the exposure factors obtained from these distances. Select a site category in which the horizontal distances in all four directions are satisfied, and in cases where the site is more susceptible to the effects of solar radiation due to values for the horizontal

distance in one direction exceeding those shown in Table 2, please regard this site as satisfying the horizontal distance in the direction in question (for example, if the horizontal distances to adjacent buildings and other objects are north 6 m, east 3 m, south 8 m and west 3 m, this is Site 2).

- In addition, please regard sides that are oriented within  $\pm 45^\circ$  of true south as being south-facing.
- In cases where there is continuous vegetation surrounding the building and a clear solar shading effect is expected, it is considered appropriate to regard such sites as a site category that is less susceptible to the effects of solar radiation.
- Details of the solar shading effect of adjacent buildings and other objects are explained in Section 4.2.3: 2 Confirming site conditions and considering building location.

## 2) Solar Shading Methods

- The following methods have been adopted in this document as solar shading methods that have a cooling energy reduction effect.

Method 1	: Solar shading methods using outside shading devices
Method 2	: Solar shading methods using the building envelope

- The details of each method are explained in 4.2.4 Solar Shading Methods.
- In order to judge whether the target level has been achieved, specifications thought to be typical have been set for each method. Please refer to these specifications and consider design specifications.

### (1) Method 1: Outside shading devices

- Components such as overhangs, blocks with decorative openings, and external shading components (such as louvers, hereafter called “outside shading devices”) have a solar shading effect. Of these, overhangs have an effect on the amount of solar radiation that penetrates the building depending on the window-overhang distance (the distance from the bottom of the window to the top of the overhang), the height of the window, the degree to which the overhang protrudes, the width of the overhang and other factors. Additionally, the solar shading effect increases dramatically if blocks with decorative openings are used.
- The solar shading effect from outside shading devices is indicated by the shading coefficient. A lower shading coefficient means a higher solar shading effect (See p.177).
- In this document, because the specifications of outside shading devices are set by dividing them into different classes, please select a class that corresponds to the design specifications (Table 3, Fig. 1). Class

Table 3 Classes and specifications of outside shading devices

Class of outside shading device	Orientation	Shading coefficient	Overhangs* <sup>1</sup>			Blocks with decorative openings, louvers etc.
			Window-overhang distance (mm)	Window height (mm)	Overhang protrusion (mm)	
Class - 1		1.0 (all orientations)	Does not satisfy class 0			
Class 0	North	0.64	0	$\leq 900$	$\geq 200$	
	East	0.75	0	$\leq 1300$	$\geq 200$	
	South	0.65	$\leq 400$	$\leq 2000$	$\geq 600$	
	West	0.65	$\leq 400$	$\leq 1300$	$\geq 600$	
Class 1	North	0.64	0	$\leq 900$	$\geq 200$	
	East	0.65	$\leq 400$	$\leq 1300$	$\geq 600$	
	South	0.52	$\leq 400$	$\leq 2000$	$\geq 1000$	
	West	0.53	$\leq 400$	$\leq 1300$	$\geq 1000$	
Class 2	North	0.49	$\leq 400$	$\leq 900$	$\geq 600$	
	East	0.53	$\leq 400$	$\leq 1300$	$\geq 1000$	
	South	0.43	$\leq 400$	$\leq 2000$	$\geq 1500$	
	West	0.43	$\leq 400$	$\leq 1300$	$\geq 1500$	
Class 3	North	0.49	$\leq 400$	$\leq 900$	$\geq 600$	
	East	0.53	$\leq 400$	$\leq 1300$	$\geq 1000$	
	South	0.43	$\leq 400$	$\leq 2000$	$\geq 1500$	
	West	0.06	$\leq 400$	$\leq 1300$	$\geq 1500$	Block* <sup>2</sup>

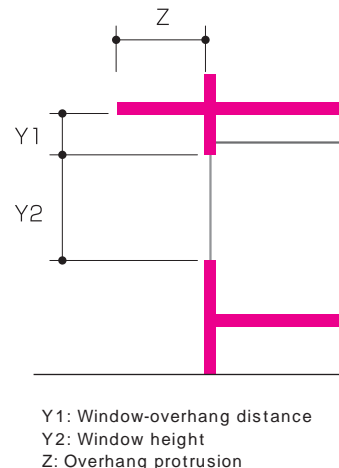

Fig. 1 Construction of overhang and each component

\* 1. The width of the overhang is assumed to be at least the width of the window.  
\* 2. The overhang is installed between the exterior wall and the decorative block.

# 4

0 is a fairly basic specification, and the solar shading effect increases in the order of Class 1, Class 2 and Class 3.

- Table 3 shows the outside shading devices (overhangs, blocks with decorative openings, louvers and other features) facing in the directions north, east, south and west, which are the conditions for each class, and the shading coefficients obtained from these devices. Please select a class in which the outside shading device specifications in all four directions are satisfied. In cases where the outside shading device specification in one direction is regarded as having a solar shading effect lower than that shown in Table 3, please regard this as corresponding with the class satisfying the outside shading device specification in the direction in question.

- In addition, please regard sides that are oriented within  $\pm 45^\circ$  of true south as being south-facing.

## (2) Method 2: Solar shading methods using building envelope

- With regard to the concrete envelope of the roof and exterior walls, the presence or absence of ventilated cavities and insulating schemes, as well as the solar radiation reflectance of surfaces, affect the amount of solar radiation that penetrates the building. Various combinations of these solar shading schemes have been considered, but although schemes for roofs that are directly struck by solar radiation are particularly important in hot humid regions, the following characteristics have also been observed.
- Insulation has the effect of limiting the amount of solar radiation that penetrates a building, but because it also prevents heat from escaping from inside the building at night, it is not always recommended in hot humid regions.
- By raising the solar radiation reflectance of the surface of the roof, the effect of ventilated cavities and insulation is reduced.
- If insulation is applied to the roof, almost no effect is achieved by ventilated cavities.
- With these characteristics in mind, because the following four types of specification have been set for the envelope of the roof and the exterior walls, please select a specification that corresponds to the design specifications (Table 4). There is no exterior wall insulation in any of the specifications. In addition, Specification 1 corresponds to a standard specification in which no particular solar shading schemes have been incorporated.

Specification 1 : No insulation, no schemes

Specification 2 : No insulation, roof cavity ventilation (ventilated cavity maintained on roof surface)

Specification 3 : Roof insulation (insulation incorporated into roof)

Specification 4 : No insulation, roof reflection (raises solar radiation reflectance of roof surface)

Table 4 Building envelope specifications for solar shading schemes

Envelope specification type	Exterior walls				Roof				Ratio of solar radiation penetrating envelope <sup>3</sup>
	Ventilated cavity	Insulation schemes	Solar radiation reflectance <sup>1</sup>	Solar penetration rate	Ventilated cavity	Insulation schemes	Solar radiation reflectance <sup>1</sup>	Solar penetration rate	
Specification 1 (No insulation, no schemes)	No	No	0.4	0.097	No	No	0.4	0.118	100%
Specification 2 (No insulation, roof cavity ventilation)	No	No	0.4	0.097	Yes	No	0.4	0.054	58%
Specification 3 (Roof insulation)	No	No	0.4	0.097	No	Yes <sup>2</sup>	0.4	0.022	37%
Specification 4 (No insulation, roof reflection)	No	No	0.4	0.097	No	No	0.7	0.059	61%

1. The solar radiation reflectance of the finishing material on the outer surface of the exterior walls and the roof; the values have the following characteristics:

0.4 = Moderate reflection (concrete, light-colored paints, etc.); 0.7 = High reflection (white paint, etc.)

2. The solar penetration rate when a type 2 extruded polystyrene foam insulating sheet (30 mm) is installed.

3. The ratio when Envelope Specification 1 is set to be 100% (standard); the amount of solar penetration is calculated from the following formula:

Amount of solar penetration = (exterior wall area x exterior wall solar penetration rate) + (roof area x roof solar penetration rate)

(Uses the areas from the Type A house model on p.344)

The amount of solar radiation that penetrates the envelope corresponds to the contribution to the M value of the solar heat gain that passes through the envelope (if the exposure factor for more than 10m is assumed).



### 3. How to achieve target levels

- Based on a standard house model in hot humid regions, the results are shown for the M value calculations obtained by combining the envelope solar shading specifications and the outside shading device classes for each of Site 1, Site 2 and Site 3 (Table 5).
- The M values in Table 5 are calculated by setting the envelope and opening specifications as shown in Table 6.
- The different colors in Table 5 correspond with the level.
- Even if the envelope specifications are the same, the level may increase if the schemes using outside shading devices are enhanced.

Table 5 Solar penetration coefficient (M value) by combining outside shading devices and building envelopes

(1) Site 1

Envelope specification type	Outside shading devices*							
	Class 0		Class 1		Class 2		Class 3	
	North	≥200	North	≥200	North	≥600	North	≥600
	East	≥200	East	≥600	East	≥1000	East	≥1000
	South/West	≥600	South/West	≥1000	South/West	≥1500	South/West	≥1500 (decorative block (W))
Specification 1 (No insulation, no schemes)	0.166		0.159		0.151		0.148	
Specification 2 (No insulation, roof cavity ventilation)	0.102		0.095		0.087		0.084	
Specification 3 (Roof insulation)	0.070		0.063		0.055		0.052	
Specification 4 (No insulation, roof reflection)	0.107		0.100		0.092		0.089	

(2) Site 2

Envelope specification type	Outside shading devices*							
	Class 0		Class 1		Class 2		Class 3	
	North	≥200	North	≥200	North	≥600	North	≥600
	East	≥200	East	≥600	East	≥1000	East	≥1000
	South/West	≥600	South/West	≥1000	South/West	≥1500	South/West	≥1500 (decorative block (W))
Specification 1 (No insulation, no schemes)	0.173		0.165		0.156		0.151	
Specification 2 (No insulation, roof cavity ventilation)	0.109		0.101		0.092		0.087	
Specification 3 (Roof insulation)	0.077		0.069		0.060		0.055	
Specification 4 (No insulation, roof reflection)	0.114		0.106		0.097		0.092	

(3) Site 3

Envelope specification type	Outside shading devices*							
	Class 0		Class 1		Class 2		Class 3	
	North	≥200	North	≥200	North	≥600	North	≥600
	East	≥200	East	≥600	East	≥1000	East	≥1000
	South/West	≥600	South/West	≥1000	South/West	≥1500	South/West	≥1500 (decorative block (W))
Specification 1 (No insulation, no schemes)	0.180		0.171		0.161		0.155	
Specification 2 (No insulation, roof cavity ventilation)	0.116		0.107		0.097		0.091	
Specification 3 (Roof insulation)	0.084		0.075		0.065		0.059	
Specification 4 (No insulation, roof reflection)	0.121		0.112		0.102		0.096	

\* Of the class requirements (Table 3 on p.167), the outside shading devices columns refer only to the hangover protrusion and the presence or absence of decorative blocks.

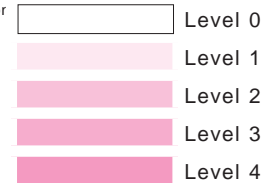

Table 6 Standard specifications for envelopes and openings

No insulation	No insulation on exterior walls or roof
Roof cavity ventilation	Spreading blocks, sheet-like panels and other devices installed on roof (See Fig. 13 on p.183.)
Roof insulation	Type 2 extruded polystyrene foam insulating sheet (30 mm) installed (thermal resistance of insulating material = 0.8 m <sup>2</sup> •K/W).
Roof reflection	Solar radiation reflectance of roof = ≥0.7 (white paint)
Openings (shared)	Standard single layer glass + sheer curtains

1. Except for cases in which roof reflection is incorporated, the solar radiation reflectance of the surface of the roof and exterior walls is 0.4 (concrete, light-colored paints, etc.)
2. The solar penetration rate of openings is 0.56 (See p.72).

# 4

## Comment Methods for determining M values by calculation

Energy conservation target levels by solar shading methods can be determined by using the summer solar gain coefficient (M value) as an indicator. In subsection 3 of Section 4.2.2, methods were shown in which M values determined by envelope (roof and exterior walls) specifications and outside shading device (overhangs, etc.) specifications are selected.

Here, we will explain methods for calculating M values according to design specifications.

M values can be calculated using the following formula:

$$\text{M value} = (\text{sum of component/orientation-specific M values}) / (\text{total floor area of house})$$

Here, “component” means the building envelope (roof and exterior walls) and openings (windows, doors, etc.), but M values are obtained for each orientation in which these components face (vertical surfaces that face east, west, north and south as well as horizontal surfaces). These M values can be calculated using the following formula:

Component/orientation-specific M value

$$= \text{exposure factor of component} \times \text{shading coefficient of outside shading devices} \times \text{solar penetration rate of component} \times \text{area of component}$$

\* For the exposure factors of components, see Table 2 on p.168 and Fig. 3 on p.174.

For shading coefficients of outside shading devices, see Table 3 on p.169, Figs. 6 and 7 on p.178, Table 7 on p.179 and Fig. 11 on p.180.

For the solar penetration rates of components, see Table 4 on p.170, Table 8 on p.182, and Table 9 on p.186.

For the areas of components, please use the projected areas of the roof, exterior walls, windows, etc.

A calculation table and sample calculations are shown below. For the type A house model (standard model, see p.344) designed in order to calculate the energy conservation effect, the M value for the house as a whole was 0.096 (level 4), based on the following calculation conditions.

Component	Orientation	Exposure factor (A)	Shading coefficient of outside shading devices (B)	Solar penetration rate of component (C)	Area (m <sup>2</sup> ) (D)	M value (A x B x C x D)
Roof	Horizontal	1.0	1.0	0.059	134.51	7.936
Exterior walls	North	0.39	0.49	0.097	39.29	0.728
	East	0.39	0.53	0.097	21.18	0.425
	South	0.49	0.43	0.097	28.93	0.591
	West	0.47	0.06	0.097	22.74	0.062
Windows	North	0.39	0.49	0.56	6.18	0.661
	East	0.39	0.53	0.56	4.86	0.563
	South	0.49	0.43	0.56	12.95	1.528
	West	0.47	0.06	0.56	1.50	0.024
Doors	South	0.49	0.43	0.56	3.60	0.425
	West	0.47	0.06	0.56	1.80	0.028
Total (E)						12.971
Total floor area (m <sup>2</sup> ) (S)						134.510
M value (E/S)						0.096

Calculation conditions

(A) Exposure factor: Site 3 (suburbs away from city center) exposure factor

(B) Shading coefficient of outside shading devices: Class 3

(C) Solar penetration rate of component: Specification 4 (No insulation, roof reflection)

(D) Area of roof, exterior walls, windows, etc., of Type A house model

## Comment Methods for calculating cooling load from M value

- The diagram shows the relationship between M value and cooling load, based on numerical simulations using a standard house in a hot humid region as a model. The gradient of the plot in cases where roof solar shading methods comprise insulation or cavity ventilation is different from that in cases where the solar radiation reflectance is used, and even if the M values are the same, the cooling load tends to be smaller when solar radiation reflection is used compared to when insulation or cavity ventilation is used.
- The relationship between M value and cooling load can be shown by the following formula for each roof solar shading scheme. By using this formula, it is possible to calculate an approximate cooling load by obtaining the M value of the house.

(1) If the roof solar shading method comprises insulation or cavity ventilation:

$$\text{Cooling load (MJ)} = 77,289 \times \text{M value} + 13,795$$

(2) If the roof solar shading method comprises solar radiation reflection:

$$\text{Cooling load (MJ)} = 125,473 \times \text{M value} + 5,340.6$$

[ Sample calculation ]

If the M value obtained by using solar radiation reflection as the roof solar shading method is 0.096:

$$\begin{aligned} \text{(From formula (2) above): Cooling load (MJ)} &= 125,473 \times 0.096 + 5,340.6 \\ &= 17,386.0 \text{ (MJ)} \end{aligned}$$

Reference: Using a numerical simulation, the cooling load of a house corresponding to level 0 was approximately 27,100 MJ (standard value). From this, it can be seen that the cooling energy reduction rate of a house fitted with the schemes mentioned above is approximately 35%.

$$\begin{aligned} \text{Cooling energy reduction rate (\%)} &= \left(1 - \frac{17,386}{27,100}\right) \times 100 \\ &= 35.8 \text{ (\%)} \end{aligned}$$

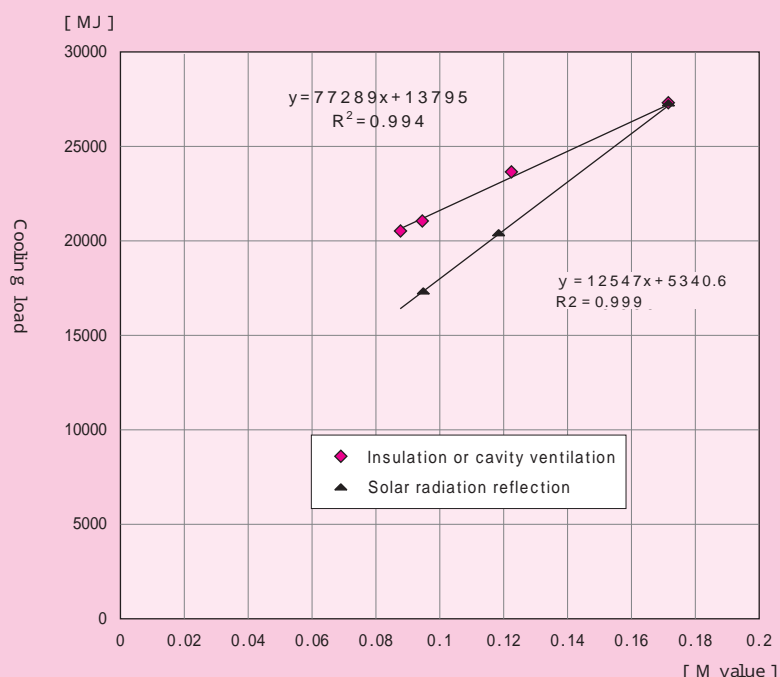

Fig. Relationship between M value and cooling load in houses in hot humid regions

# 4

Chapter 4  
Heat Control Technology of  
Building Envelopes  
(Elemental Technology  
Application Method 2)

## 4.2.3 Steps for Examining Solar Shading Technology and Confirmation of Site Conditions

### 1 Steps for examining solar shading technology

#### Step 1 Set the target level

- Set the cooling energy reduction rate.

#### Step 2 Confirm site conditions and consider building location

- Confirm conditions around building site and consider building location.
- Select corresponding “site conditions”.

#### Step 3 Consider applying solar shading methods using outside shading devices

- Confirm the amount of solar radiation incident upon the exterior walls and roof.
- Taking into account orientation, consider incorporating overhangs, blocks with decorative openings, external solar shading components and other devices.
- Select corresponding “outside shading device class”.

#### Step 4 Consider applying solar shading methods using building envelope

- Consider roof solar shading specifications.
- Consider exterior wall solar shading specifications.

#### Step 5 Confirm cooling energy reduction rate from applying solar shading methods

- Investigate M value and confirm cooling energy reduction rate.

## 2 Confirming site conditions and considering building location

- Solar radiation that strikes the exterior walls of a house can be shaded by adjacent buildings or, in the case of hilly land, diagonal surfaces (hereafter called “adjacent buildings”). The effect of this shading can be more or less determined by the ratio of the difference in elevation of an adjacent building that acts as a shading object divided by the horizontal distance to the adjacent building. If the horizontal distance between the exterior wall of the house in question and that of the adjacent building is 10 m or less, a solar shading effect takes place.
- The relationship between the adjacent building and the difference in elevation is roughly classified into three cases, and the solar shading effects (exposure factors) differ as shown below (Figs. 2 and 3).
- As shown in Case (1), if there are no adjacent buildings within 10 m of the house in question (for example, if there is no house opposite a one-storey house, or in the case of a second-floor room, if there is a one-storey building opposite a two-storey house), the solar radiation is not shaded.
- As shown in Case (2), if there is an adjacent building that has the same number of stories as the house in question (for example, if there is a one-storey building opposite a one-storey house or if there is a two-storey building opposite a two-storey house), the solar radiation is shaded.
- As shown in Case (3), if there is an adjacent building that has one storey more than the house in question (for example, if there is a two-storey building opposite a one-storey house), the solar shading effect is stronger than that is Case (2).
- By taking into account this type of situation surrounding a house and applying solar shading methods by focusing on those components that are more susceptible to solar radiation, it is possible to effectively improve solar shading performance.
- On the other hand, solar radiation on the roof can also be shaded by adjacent buildings and other objects. However, solar radiation on a roof surface shaded by adjacent buildings occurs when the sun is low in the sky and the amount of solar radiation is small, such as early in the morning or in the evening. Little shading occurs during the middle of the day, when the amount of solar radiation incident upon the surface of a roof is large. In addition, it is the edges of the roof that are shaded, with the center of the roof having little sun shadow. Therefore, solar shading of roofs by adjacent buildings and other objects is not taken into account; in other words, the exposure factor of the roof is regarded as being 1, regardless of the surrounding conditions (Fig. 4).

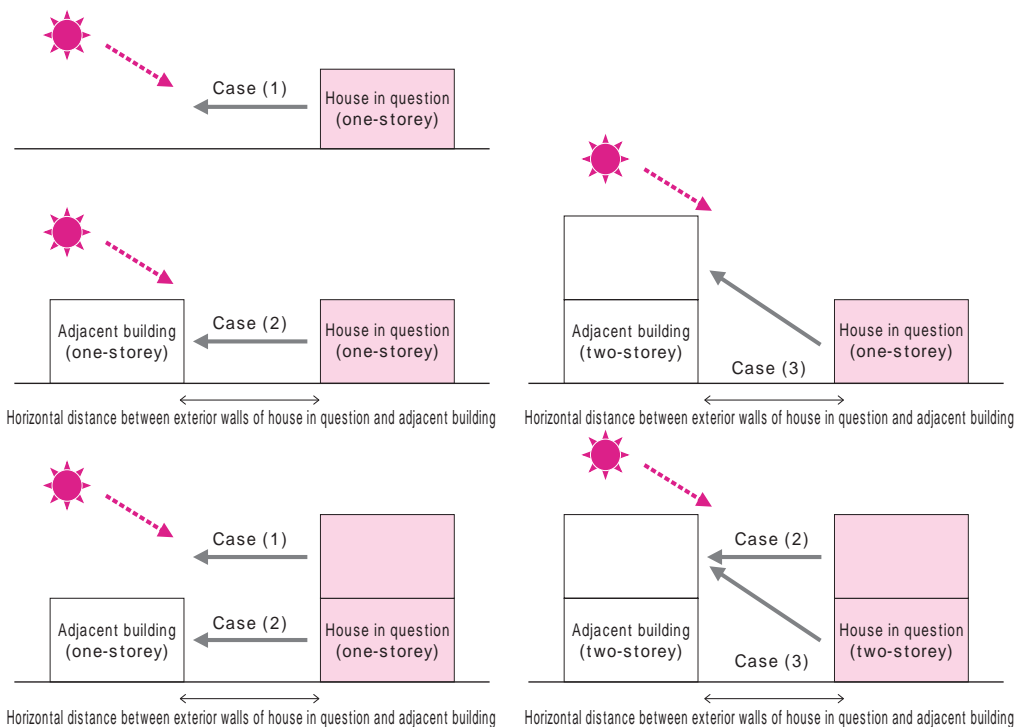
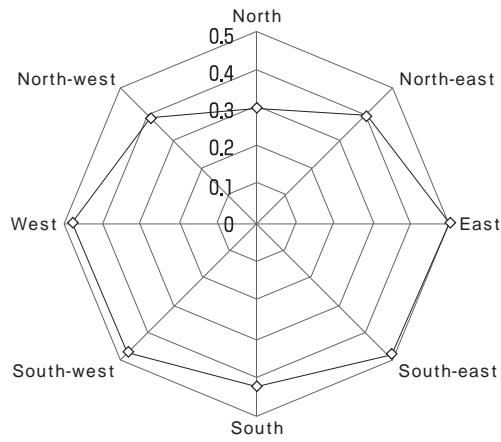

Fig. 2 Relationship between adjacent buildings and difference in elevation

# 4

Chapter 4  
Heat Control Technology of  
Building Envelopes  
(Elemental Technology  
Application Method 2)



Case (1): No adjacent building within 10 m

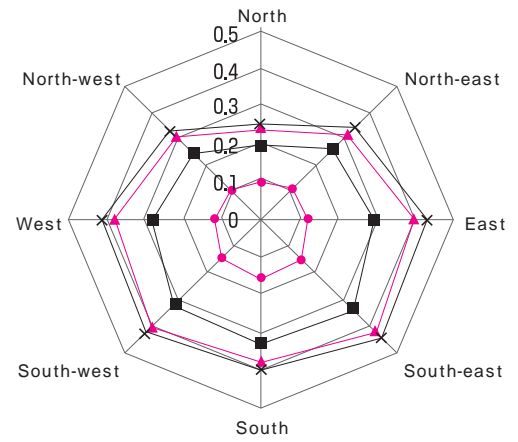

Case (2): Adjacent building that has the same number of storeys as the house in question

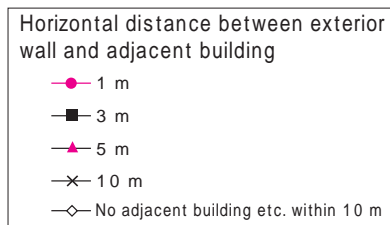

The orientations in the graphs indicate the orientations of the walls.

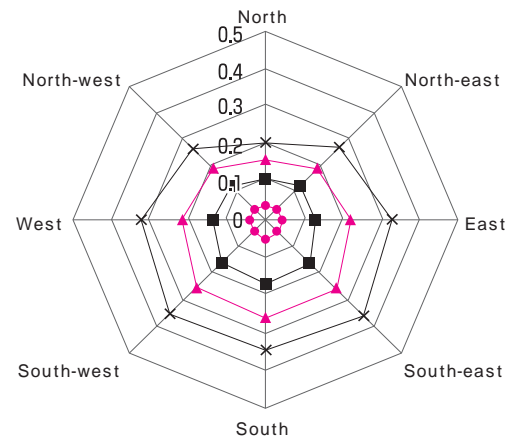

Case (3): Adjacent building one storey higher than the house in question

Fig. 3 Differences in exposure factor due to presence/absence of adjacent buildings ; Naha, Mar. 25 Dec. 14 (cooling period)

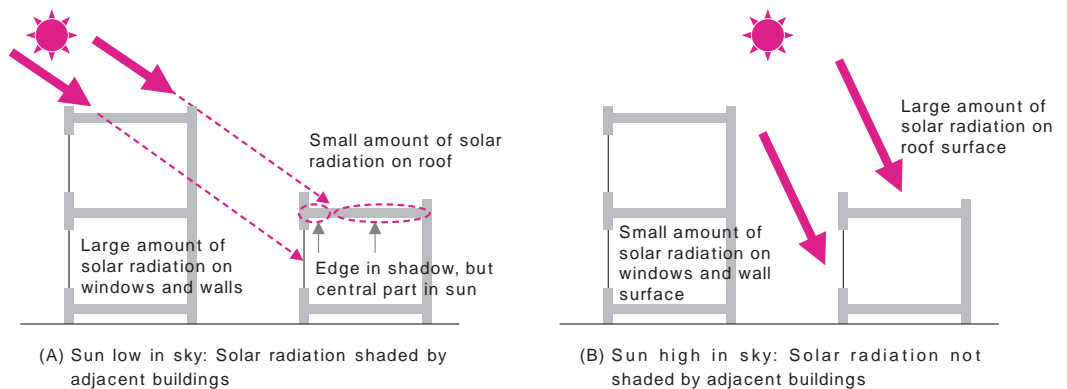

Fig. 4 Shading of roof by adjacent buildings

## 4.2.4 Solar Shading Methods

### Method 1 : Solar shading methods using outside shading devices

- This method shades solar radiation through the use of devices mounted outside the windows; for example, external solar shading components such as overhangs, blocks with decorative openings or louvers. Once solar radiation heat enters a room, it causes the temperature inside the room to increase until discharged, and solar shading must therefore be applied on the outside of the windows.
- If using blocks with decorative openings that cover the whole of the *amahaji* or wall surface, this has the effect of shading solar radiation that enters the room not only from the windows, but also from the wall surface.
- The effect of solar shading by outside shading devices is indicated by the shading coefficient. A smaller shading coefficient means a higher solar shading effect.

$$\text{Shading coefficient} = \frac{\text{Amount of solar radiation penetrating the window if outside shading devices are fitted}}{\text{Amount of solar radiation penetrating the window if outside shading devices are not fitted}}$$

#### 1. Overhangs

- Overhangs mainly shade solar radiation that strikes windows and walls from above. As a result, the solar shading effect of overhangs is at its highest when direct solar radiation strikes the south side of a building when the sun is high in the sky and the weather is fine. In addition, the greater the degree of protrusion of the overhang, the higher the shading effect (Figs. 5 and 6).
- Solar radiation strikes windows and wall surfaces from the side as well as from the front. Therefore, installing a wide overhang that covers more than one window achieves a higher shading effect than fitting a small, narrow overhang to each window (Fig. 6).
- Because solar radiation strikes east- and west-facing surfaces when the sun is low in the sky, the shading effect due to overhangs is less for the lower parts of windows (Figs. 6 and 7). In such cases, also using a block with decorative openings increases the shading effect for those lower parts of windows that are not shaded by overhangs.
- Fitting overhangs immediately above windows increases the shading effect (Fig. 7). It is possible to achieve a solar shading effect even with small overhangs by installing them as near as possible to the tops of windows.

# 4

## Chapter 4 Heat Control Technology of Building Envelopes (Elemental Technology Application Method 2)

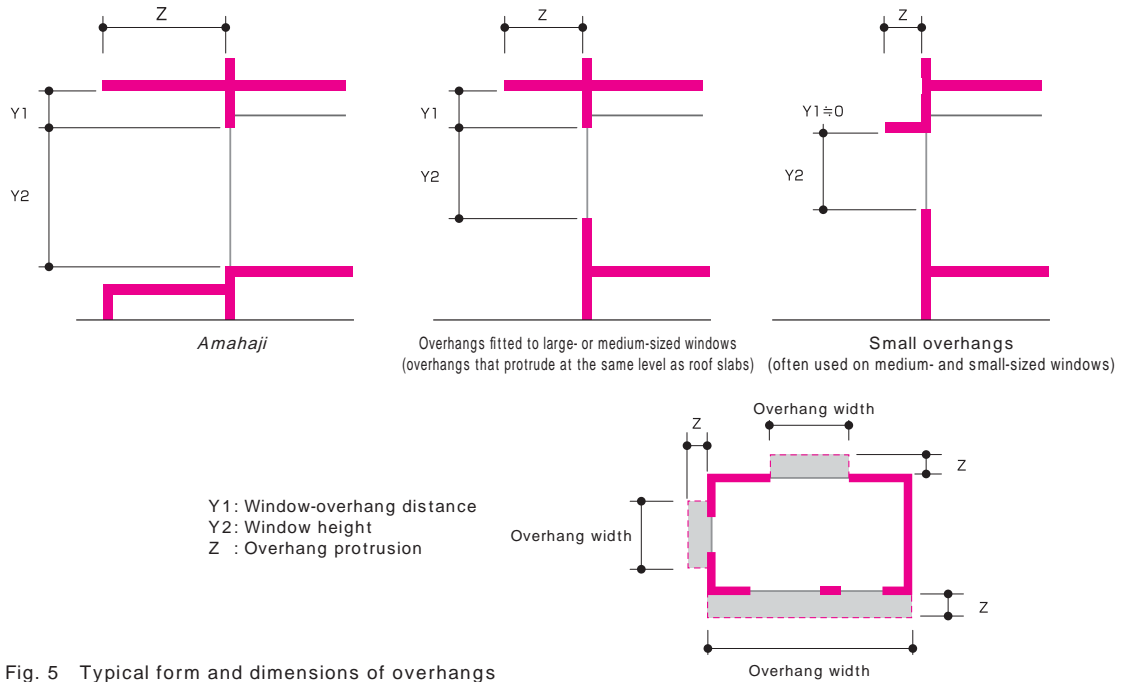
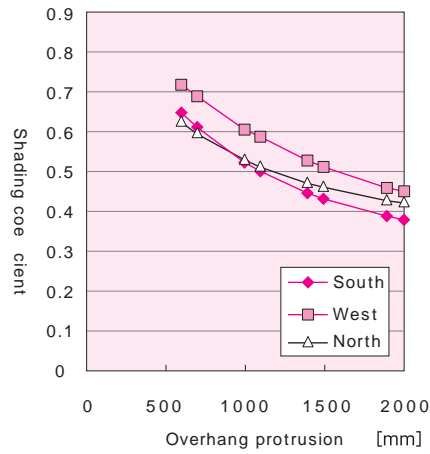
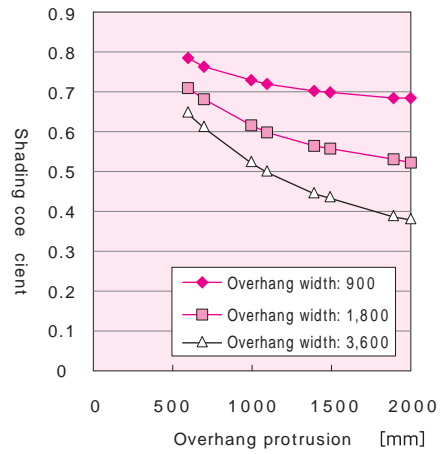

Fig. 5 Typical form and dimensions of overhangs



(A) Differences in shading coefficient due to differences in installation orientation  
Window-overhang distance 400 mm; Window height 2,000 mm; Overhang width 3,600 mm



(B) Differences in shading coefficient due to differences in overhang width  
Window-overhang distance 400 mm; Window height 2,000 mm; Installation orientation: south

Fig. 6 Relationship between overhang protrusion dimensions and shading coefficient

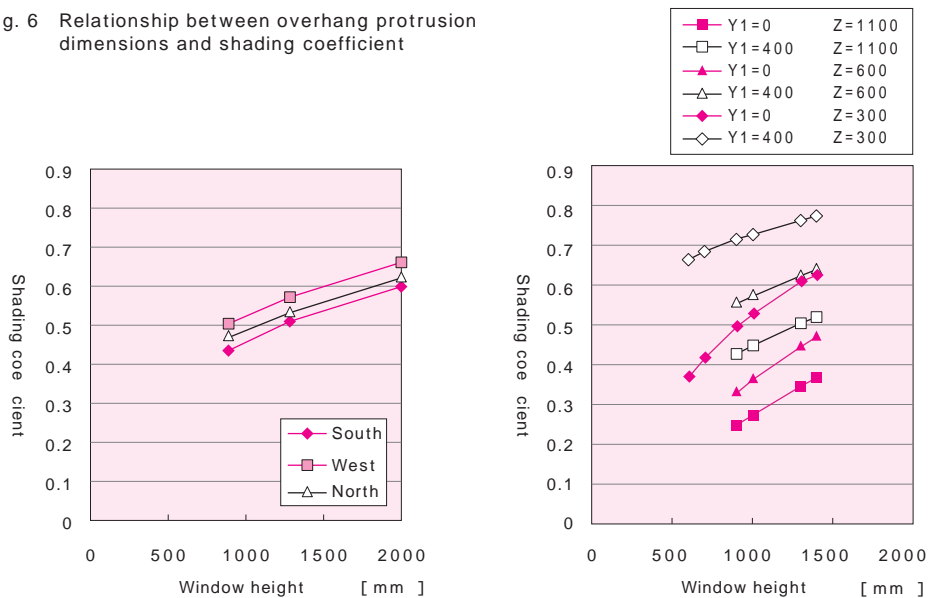

(A) Y1 = 400; Z = 1,100; Overhang width = 1,800

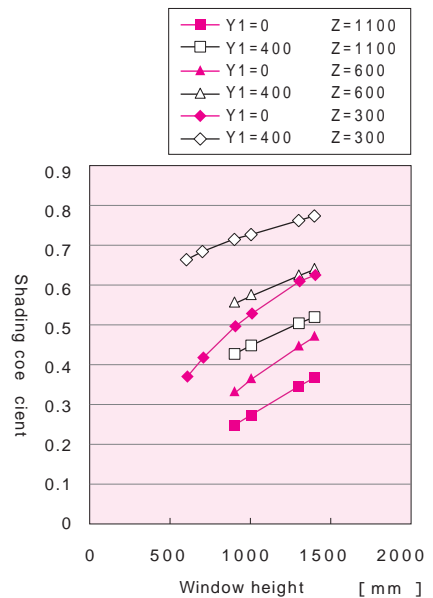

(A) Overhang width = 1,800; Installation orientation: south

Fig. 7 Relationship between window height and shading coefficient



## 2. Blocks with decorative openings

- Blocks with decorative openings achieve a high solar shading effect for components such as those on west-facing surfaces struck by solar radiation when the sun is low in the sky.
- The shading coefficient is 0.1 or lower for blocks with decorative openings that have dimensions such as those shown in Fig. 8 (Table 7). This value assumes that solar radiation does not enter the room from above, between blocks or window surfaces, due to the additional use of overhangs and other components.
- Blocks with decorative openings achieve a higher solar shading effect if the area of the openings is smaller. On the other hand, because shading solar radiation means shading natural light, the brightness inside the room must be taken into account. South-facing components that are struck by solar radiation when the sun is high in the sky allow in diffused light while shading direct solar radiation through the use of overhangs, but by using blocks with decorative openings or louvers (See next section) on west-facing components that are struck by direct solar radiation when the sun is low in the sky, it is easier to achieve solar shading that strikes a balance with daylighting.

Table 7 Shading coefficients of blocks with decorative openings

Orientation	Shading coefficient
North	0.03
East	0.06
South	0.02
West	0.06

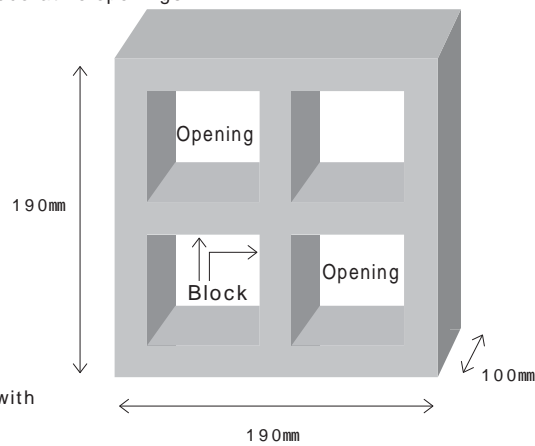

Fig. 8 Example of shape of block with decorative openings

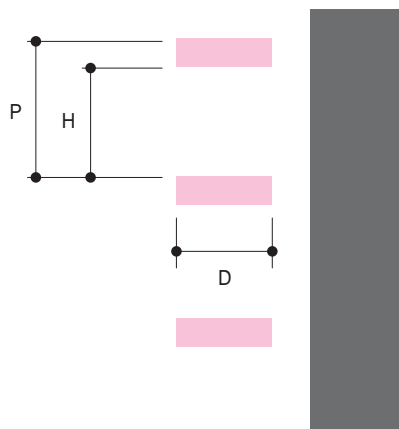

Fig. 9 Examples of usage of blocks with decorative openings

# 4

## 3. External solar shading components (louvers, etc.)

- External solar shading components such as louvers achieve solar shading by covering windows and other openings in the same way as blocks with decorative openings, and achieve a high solar shading effect even for west-facing components that are struck by direct solar radiation when the sun is low in the sky. In addition, with movable louvers, it is possible to prioritize solar shading when the amount of solar radiation is high according to the time or the weather, and to prioritize daylighting and maintaining the view when the amount of solar radiation is low.
- The solar shading effect is higher if the holes (H) in the louver are smaller and the depth (D) of the louver is larger (Figs. 10 and 11).
- As shown in (A), in the case of a louver having large holes (H), diffused light can easily enter through the holes in the louver, improving the view outside. If louvers are fitted to habitable room windows and there are no other windows, a balance needs to be struck between lighting/view and solar shading.
- As shown in (B), louvers with small holes (H) have a higher solar shading effect and are effective if used in cases where east- and west-facing surfaces receive a large amount of sun.



Shading coefficient = approximately 0.25 if  $P = 100$ ,  $H = 80$ , and  $D = 50$

(A) Type of louver that allows light in and improve the outside view

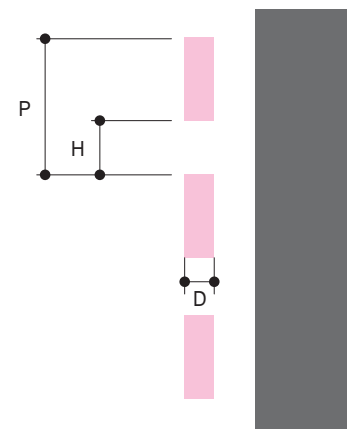

Shading coefficient = approximately 0.15 if  $P = 100$ ,  $H = 30$ , and  $D = 15$

(B) Type of louver that increases the solar shading effect and keeps the louver thin

Fig. 10 Types and dimensions of louvers

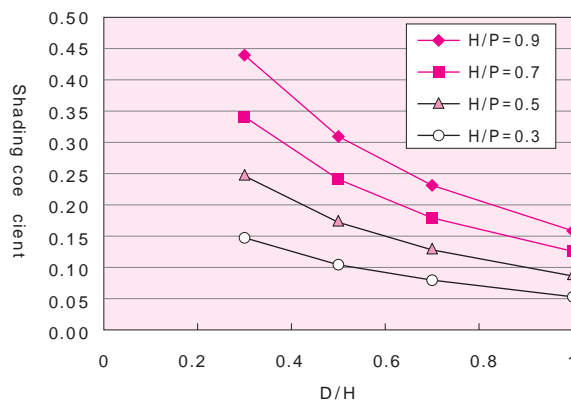

Fig. 11 Shading coefficients when louvers are installed (Ratio of the amount of solar radiation when louvers are fitted; where no louvers are fitted the value is 1)



Fig. 12 Examples of usage of louvers



# 4

cannot be said to be suitable for hot humid regions. Metal (aluminum) sash windows using ordinary single glazing are generally used in hot humid regions.

## 2. Roofs

### 1) Methods and effects of solar shading

- Roofs are the component most susceptible to solar radiation, and are therefore the component most in need of solar shading measures, after windows, in the building envelope.
- Correlations between roof solar shading schemes have the following characteristics:
- If solar radiation reflection is increased, insulation has no significant effect.
- If solar radiation reflection is increased or insulation is incorporated, cavity ventilation has no significant effect.
- Therefore, selecting and incorporating one of solar radiation reflection, insulation, or cavity ventilation is considered to be effective.
- In cases where it is not possible to use brightly colored building materials (for reasons of design or in order to prevent inconvenience to neighbors due to solar radiation reflection), it is possible to use a method that involves applying heat-shielding paints, as explained in Method 3 (Solar shading methods for exterior walls).
- Roofs on roofed balconies, which are common in Okinawa, can be regarded as providing a ventilated cavity having sufficient ventilation, and are considered effective as a roof solar shading scheme for the first floor of a house. Skylights are effective in terms of cross ventilation only if this type of solar shading device is present, but cannot be recommended without a solar shading scheme.
- Table 8 shows differences in solar penetration rates due to differences in roof specifications. Thermal resistance values of insulating materials and corresponding differences in specification are arranged in the vertical direction, the presence/absence of ventilated cavities and differences in solar radiation reflectance are arranged in the horizontal direction, and solar penetration rates under these various conditions are shown.
- Even without insulation, Table 8 demonstrates that incorporating cavity ventilation or solar radiation reflection schemes makes it possible to reduce the solar penetration rate compared to no insulation with no improvements.
- In addition, even if cavity ventilation or solar radiation reflection schemes are not incorporated, Table 8 demonstrates that it is possible to reduce the solar penetration rate by installing insulation. By increasing the level of insulation, the solar penetration rate decreases. But since maintaining an insulating material with a thermal resistance value of 0.8 m<sup>2</sup>•K/W (corresponding to a 30 mm type 2 extruded polystyrene foam insulating sheet installed) means that heat is prevented from escaping during the night or at other times, the cooling energy reduction effect from increasing the thickness of the insulation is slight.
- The solar penetration rates in Table 8 can be used when calculating M values by numerical calculation (See Comment on p.170).

Table 8 Differences in solar penetration rates due to differences in roof specifications

Thermal resistance value of insulating material (m <sup>2</sup> •K/W)	Corresponding energy conservation standards	Example of insulating material specification	No ventilated cavity			Ventilated cavity		
			Solar radiation reflectance 0.1	Solar radiation reflectance 0.4	Solar radiation reflectance 0.7	Solar radiation reflectance 0.1	Solar radiation reflectance 0.4	Solar radiation reflectance 0.7
0		No insulation	0.179	0.118	0.059	0.082	0.054	0.026
0.5	1980 Standards	20 mm type 2 extruded polystyrene foam insulating sheet	0.048	0.032	0.016	0.039	0.025	0.013
0.8		30 mm type 2 extruded polystyrene foam insulating sheet	0.033	0.022	0.011	0.029	0.019	0.009
1.1	Standard interest rates	40 mm type 2 extruded polystyrene foam insulating sheet	0.025	0.017	0.008	0.023	0.015	0.007
1.3	1992 Standards	50 mm type 2 extruded polystyrene foam insulating sheet	0.022	0.015	0.007	0.020	0.013	0.006
1.7		50 mm type 3 extruded polystyrene foam insulating sheet	0.017	0.011	0.006	0.016	0.010	0.005
2.5	1999 Standards	75 mm type 3 extruded polystyrene foam insulating sheet	0.012	0.008	0.004	0.011	0.007	0.004

Note 1: Solar radiation reflectance values

0.1 = low reflectance (dark colored paints, etc.); 0.4 = moderate reflection (concrete, light colored paints, etc.); 0.7 = high reflection (white paints, etc.)

Note 2: Standard interest rates by the Okinawa Development Finance Corporation; construction specifications for houses for which the basic interest rate is applicable (supplemental financing construction specifications were the same in the 1999 standards)

## Key Point

### Changes in ceiling surface temperature due to differences in roof specifications

- The diagram shows ceiling surface temperatures in summer for a roof having typical specifications.
- Compared to the condition whereby no schemes are incorporated (no ventilated cavity, no insulation, normal solar radiation reflectance), increasing the solar radiation reflectance lowers the ceiling surface temperature by approximately 4°C during the day, and by approximately 0.4°C even at dawn. In addition, schemes that incorporate insulating materials lower the ceiling surface temperature by approximately 3.5°C during the day, and by approximately 1°C at midnight.
- On the other hand, schemes that incorporate ventilated cavities lower the ceiling surface temperature by approximately 3.5°C during the day, but cause the surface temperature to rise above the temperature if no schemes are incorporated between 10.00 p.m. and 8.00 a.m. The reason for it being difficult for the surface temperature to fall during the night is thought to be that heat discharge due to nocturnal radiation is inhibited by ventilated cavities.

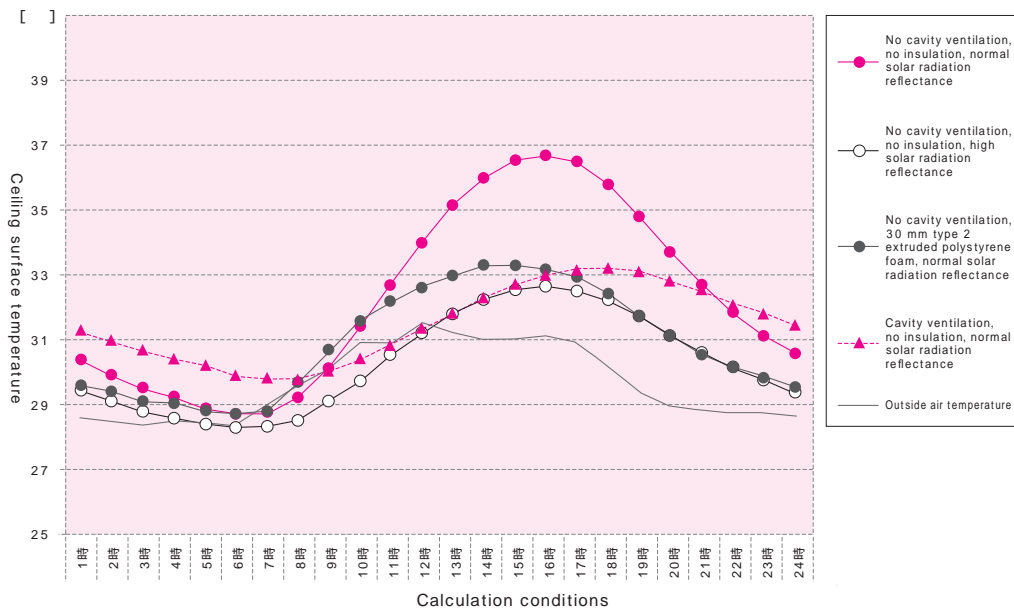

Fig. Changes in ceiling surface temperature due to differences in roof specifications

Calculation conditions  
 Average values for each time period between Aug. 1 and 10  
 Room used for test: South-east-facing Japanese style room (without cooling)  
 Exterior walls: No cavity ventilation, no insulation, normal solar radiation reflectance, no overhangs

## 2) Typical solar shading specifications

Of the roof solar shading methods, here are examples of typical ventilated cavity specifications (Fig. 13).

- In addition to being a solar penetration countermeasure, this method in which a ventilated cavity is provided by placing spreading blocks at the top of the roof greatly contributes to improving the durability of roof slabs.
- The edges of spreading blocks and other components need to be open to the outside air and constructed so as to allow sufficient ventilation within the ventilated cavity. Additionally, the thickness of the ventilated cavity is preferably at least 30 mm. Use materials having excellent corrosion resistance (anti-rust properties) for metal objects that fasten the roof bed and roofing materials.
- In Zone VI, standard methods using spreading blocks can be applied relatively easily to both existing and new houses, but care must be taken if applying to an existing roof so as not to exceed the maximum allowable load of the roof.

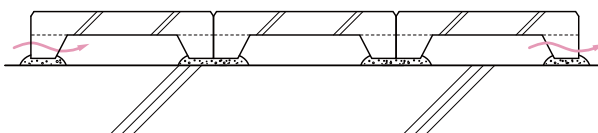

(A) Example using spreading blocks

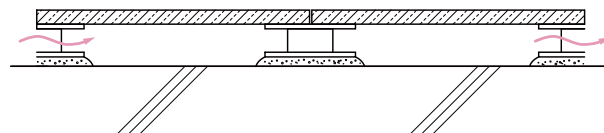

(B) Example using tiles or sheet-like panels of stone

Fig. 13 Examples of roof ventilated cavities

**Glossary: Nocturnal radiation**  
 Radiation energy transferred between objects at the same temperature as the outside air and the atmosphere above. On clear nights during the summer, there is a cooling effect equivalent to the outside air temperature falling by 2°C or more.

# 4

## Chapter 4 Heat Control Technology of Building Envelopes (Elemental Technology Application Method 2)

### Glossary: Solar radiation reflectance

The ratio of the energy reflected to the incident solar radiation energy between the visible region and the near-infrared region.

### Glossary: Long-wave radiation emissivity

Any object radiates an energy proportional to its temperature (absolute temperature) raised to the power of four. However, because this differs depending on the surface condition (color, etc.) of an object, even for objects having the same surface temperature, the emissivity is the ratio of the energy radiated by an object to the energy radiated by a perfectly black body (a theoretical object that completely absorbs all radiation). Long-wave means thermal radiation having a relatively long wavelength of approximately 3 μm or longer, which excludes solar radiation.

### Key Point

#### Solar radiation reflectance and long-wave radiation emissivity of material surfaces

- The diagram shows numerical values for the solar radiation reflectance and long-wave radiation emissivity of commonly used construction materials.
- The solar radiation absorbance values (A1) of material surfaces are plotted along the lower horizontal axis, and the solar radiation reflectance values (A2) are plotted along the upper horizontal axis. For construction materials that block the passage of solar radiation,  $A1 + A2 = 1$ . When investigating the shading performance of the surface of exterior finishing materials, refer to the values for these materials.
- The long-wave radiation emissivity values (B1) of material surfaces are plotted along the left-hand vertical axis, and the long-wave radiation reflectance values (B2) are plotted along the right-hand vertical axis. For construction materials that block the passage of solar radiation,  $B1 + B2 = 1$ . When investigating shading designs for the inside of ventilated cavities or air space, these values are used.

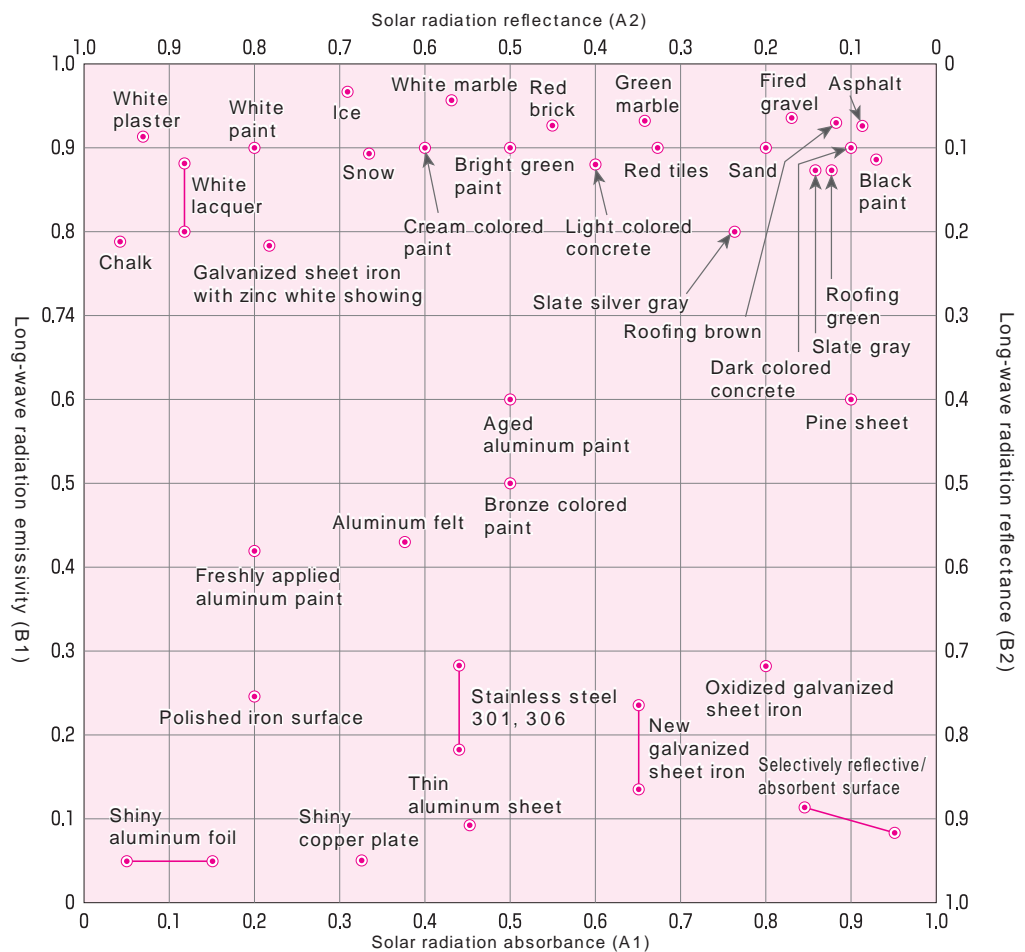

Fig. Solar radiation reflectance and long-wave radiation emissivity of material surfaces  
Reference: p.122, *Architectural Design Data Corpus 1, Environment*, The Architectural Institute of Japan, Maruzen, 1978

### Comment Schemes involving increasing long-wave radiation reflectance

One method of increasing the thermal resistance of the inside of a building envelope is to improve the long-wave radiation reflectance. This method involves fitting a material that faces into a ventilated cavity in the building envelope, that is, employing a material (or paint) having a high long-wave radiation reflectance either on the behind the exterior finishing material or on the surface of the concrete, thus enabling a significant reduction in the solar penetration rate. This method can be used not only on ventilated cavi-

ties, but also on sealed air space.

Methods have been considered in which a ventilated cavity is provided and an exterior finishing material lined with aluminum foil is then used, which can be applied relatively easily to existing as well as new houses, but because measures to counteract damage caused by salt and other factors must be taken into account in hot humid regions in particular, it can be said that more study is needed in terms of construction methods and materials.

1. Advantages of green roofs

Green roofs have the effect of limiting temperature increases on roof surfaces by using latent heat caused by a thermal transpiration effect from plants or the ground. Green roofs are often wrongly thought to alleviate indoor temperature fluctuations by making use of the insulating properties of soil, but because moist soil has a thermal conductivity that is equal to, or greater than, that of concrete, it can be said the effect of green roofs is more based on a thermal transpiration effect than insulation. In addition, it is hoped that it will be possible to improve the durability of building envelopes made of concrete and other materials by covering roofs with soil or plants.

Moreover, the solar shielding effect of green roofs can generally be thought of as equivalent to providing a ventilated cavity.

2. Points to note when installing green roofs

Because there are many reinforced concrete houses in Okinawa, it is easy to install green roofs on both new and existing houses, but consideration must be given to design, construction, and maintenance matters.

- With regard to the selection of plants, it is important to choose ones that are resistant to salt damage. Greening with grasses is also recommended from the perspective of dealing with high winds and heavy rain during typhoons. The table below gives examples of plants used for green roofs in Okinawa.
- At the design stage, it is essential to consider the maximum allowable load on a roof by taking into account the load from the plants after they have grown. In addition, providing adequate drainage schemes and using con-

struction methods that do not damage the waterproof surface of the roof are important factors in preventing water leakage.

- It is important to make sure that occupiers are aware that post-occupancy maintenance is particularly important. In order for plants to grow healthily, daily care such as pruning, watering and fertilizing is essential. For reasons of structural limitations and cost, examples of thin layer greening (100-300 mm of light soil) have been seen, but controlling the moisture in the soil is difficult in such cases, meaning that the plants sometimes die. In order to prevent this, it is essential to install a drainage system on the roof so as to control the moisture content of the soil on a day-to-day basis. In addition, diligently removing fallen leaves to prevent them from blocking drains is an essential water leakage countermeasure.
- An assistance program has been established in Naha to promote the greening of roofs and walls of buildings. For green roofs, a degree of financial assistance is provided for installing greening facilities of 3 m<sup>2</sup> or more or planters of 1 m<sup>2</sup> or more, namely 50% of the construction costs or 5,000 yen per square meter of greening, whichever is smaller, to a maximum of 300,000 yen (Source: *Naha City Rooftop and Wall Greening Assistance Guidelines*).



Table: Plants used for green roofs

Vitality	Woody plants	Herbaceous plants
5		<i>Zoysia matrella</i> , El Toro/grass (hybrid)
4	<i>Ligustrum tamakii</i> Hatusima, <i>Berchemia racemosa</i> , <i>Thuarea involuta</i>	<i>Ophiopogon japonicus</i> Ker-Gawler, <i>Miscanthus</i> sp., <i>Salvia splendens</i> sp., <i>Nephrolepis auriculata</i>
3	<i>Scaevola frutescens</i> , <i>Crossostephium artemisioides</i> , <i>Zanthoxylum beecheyanum</i> , <i>Euonymus trichocarpus</i> Hay	<i>Ruellia brittoniana</i> Leonard, <i>Wedelia biflora</i> , <i>Wedelia prostrata</i> , <i>Portulaca okinawensis</i> , <i>Sesuvium portulacastrum</i>
2	<i>Psychotria serpens</i>	<i>Phyla nodiflora</i>
1		<i>Lobelia loochooensis</i> , <i>Sedum uniflorum</i> , <i>Blutaparon wrightii</i> , <i>Hedyotis biflora</i> , <i>Peperomia japonica</i>

Source: *New Okinawan Housing Proposals*, Okinawa Development Finance Corporation, September 2007

\* The plants selected had been planted for two years and were suitable for green roofs (as of March 2005). Plants with a vitality of three or more are suitable for green roofs (based on the Okinawa Commemorative National Park Management Foundation's Tropical Plants Research Report No. 26).

# 4

## 3. Exterior walls

- Regarding the solar shading of exterior walls, it is important to implement an external solar shading scheme on both exterior walls and openings using such means as *amahaji* (semi-outdoor space with a deep overhang) and blocks with decorative openings.
- If it is found by confirming the exposure factor due to site conditions (Fig. 3 on p.176) that the solar shading effect due to adjacent buildings and other factors is sufficient even compared to cases in which *amahaji* and blocks with decorative openings have been installed, it is possible to omit these features.
- If schemes involving *amahaji* and blocks with decorative openings have not been incorporated, the use of schemes similar to roof schemes (cavity ventilation, insulation, solar radiation reflection) must be considered. However, since cavity ventilation and insulation have the drawback of preventing heat from escaping during the night, detailed confirmation using M values is necessary. In addition, because solar radiation reflection involves the use of bright colors or materials that reflect light, the effect on neighbors must be taken into account.
- When suppressing the reflection of visible light and increasing the reflection of solar radiation, one method is to utilize the characteristics of heat shielding paints (See Comment on p.187).
- Table 9 shows differences in solar penetration rates due to differences in exterior wall specifications. Thermal resistance values of insulating materials and corresponding differences in specification are arranged vertically, the presence/absence of ventilated cavities and differences in solar radiation reflectance are arranged horizontally, and solar penetration rates under these various conditions are shown.

Table 9 Solar penetration rates by exterior wall specifications

Thermal resistance value of insulating material (m <sup>2</sup> •K/W)	Corresponding energy conservation standards	Example of insulating material specification	No ventilated cavity			Ventilated cavity (reference)		
			Solar radiation reflectance 0.1	Solar radiation reflectance 0.4	Solar radiation reflectance 0.6	Solar radiation reflectance 0.1	Solar radiation reflectance 0.4	Solar radiation reflectance 0.6
0	1980 Standards 1992 Standards	No insulation	0.157	0.097	0.064	0.077	0.050	0.032
0.3	1999 Standards	15 mm bead method polystyrene foam insulating sheet	0.067	0.043	0.029	0.045	0.030	0.019

Note 1: Solar radiation reflectance values

0.1 = low reflectance (dark colored paints, etc.); 0.4 = moderate reflection (concrete, light colored paints, etc.); 0.6 = fairly high reflection (heat shielding paints, etc.)

Note 2: Ventilated cavity construction method; selection of materials involved taking durability and other factors into account, but it is thought that more study is needed.



## Comment Heat shielding paints

Paints have become increasingly sophisticated in recent years. One such type of material is heat shielding paints that have increased solar radiation reflection. The diagram shows examples of reflectances of standard paints and heat shielding paints at a variety of wavelengths. With these two types of paint, there is little difference in terms of reflectance (10-40%) in the visible light region, but in the near-infrared region, which has wavelengths of longer than 800 nm, standard paints exhibit a reflectance of 20-30%, whereas heat shielding paints

exhibit a reflectance of up to 80%.

It is true that many manufacturers are selling heat shielding paints by stressing their insulation performance, but it should be noted that the effect of these materials is heat shielding performance, not insulation performance.

In addition, heat shielding paints suffer from long-term UV degradation and soiling in the same way as ordinary paints, and therefore also require periodic cleaning and maintenance such as repainting. Please refer to the manufacturer's application instructions for details.

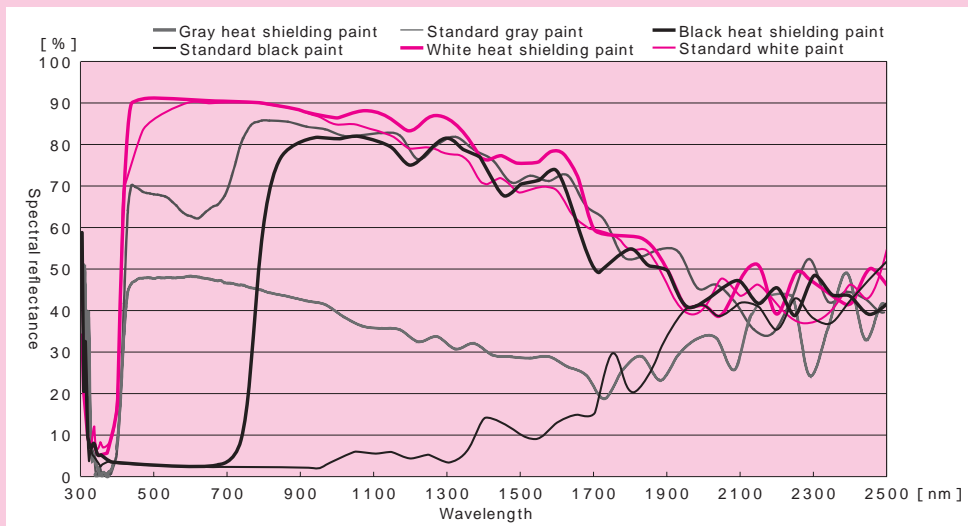
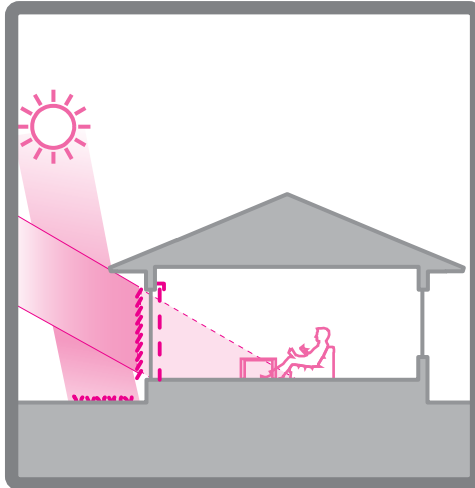

Fig. Results of reflectance measurements using heat shielding paints

# 4

Chapter 4  
Heat Control Technology of  
Building Envelopes  
(Elemental Technology  
Application Method 2)

## 4.3 Solar shading methods for Zone V



Solar shading is a technology that aims to control the excessive inflow of solar heat, reduce the amount of energy used for cooling and improve comfort by effectively shielding solar radiation that would penetrate buildings in summer and in-between seasons.

With regard to solar shading for openings, it is important to plan them in a way that solar gain in winter is also achieved while cross ventilation and daylight utilization are maintained.

### 4.3.1 Purpose and Key Points of Solar Shading

#### 1. Reducing amount of energy used for cooling

- Solar radiation has a major effect on the thermal environment in a house. In winter, heating energy can be reduced as the room temperature can be increased by gaining increased amounts of solar radiation heat. In summer, however, since there is a need to use cooling to reduce the room temperature, which increases because of solar radiation heat, the greater the amount of solar radiation is, the greater the amount of energy used for cooling becomes.
- The purpose of solar shielding is, as the expression suggests, to shade from solar radiation, thereby reducing the amount of solar radiation heat entering a building and cutting the amount of energy used for cooling.

#### 2. Maintaining cool rooms

- In order to keep rooms cool in summer and in-between seasons, solar shading is important along with cross ventilation. In order to use solar shading efficiently, it is important to take into account the directional characteristics of the components of the building envelope. By suppressing the amount of solar radiation heat entering rooms, it is possible to limit the increase in room temperature and also limit the surface temperature on the interior walls and other surfaces.

#### Key Point

Basic matters that are background knowledge for examining solar shading schemes

Differences in the amount of solar radiation due to orientation

- The amount of solar radiation striking a building differs depending on the season and the orientation of the components of the building (Fig. a). The amount of solar radiation in the summer, when the solar altitude is high in the sky, increases greatly on horizontal surfaces such as roofs, but for vertical walls, the amount of incident solar radiation is larger on east- or west-facing surfaces and smaller on south-facing surfaces. Understanding this characteristic of solar radiation is the key for effective solar shading schemes.

Fig. a  
Differences in global solar radiation level due to orientation (Average values for Jan. and Aug. in Kagoshima)

- Horizontal surfaces
- East-facing vertical surfaces
- West-facing vertical surfaces
- ◆ South-facing vertical surfaces
- ▲ North-facing vertical surfaces
- Air temperature

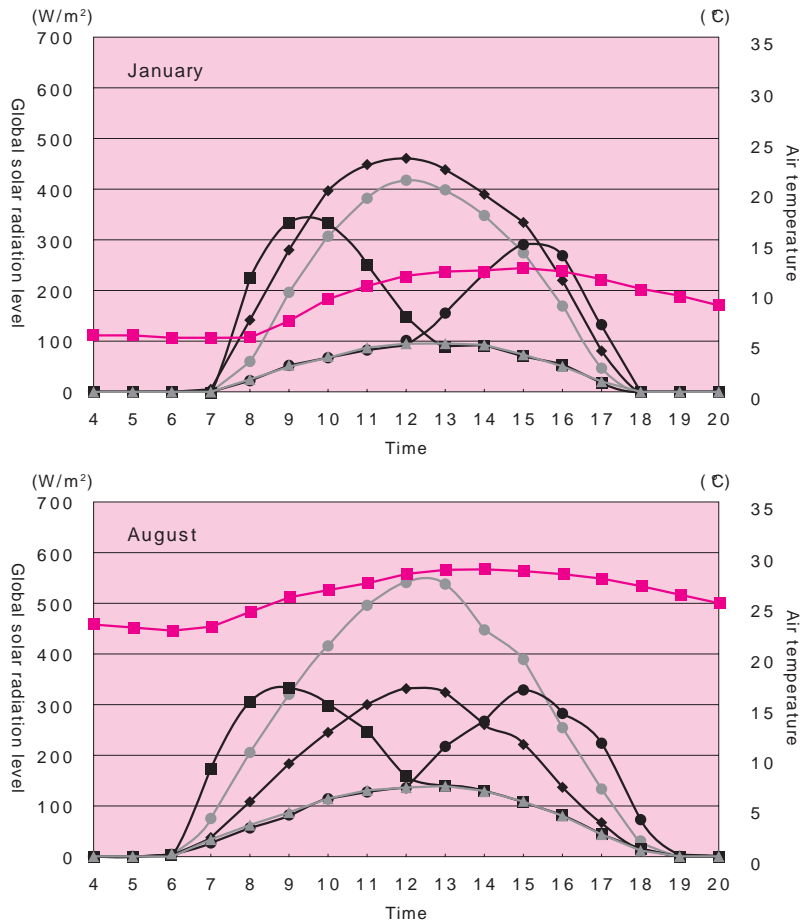

Differences in the amount of transmitted solar radiation due to transparent and non-transparent components

- As shown in Fig. b, solar radiation levels from transparent components such as windows is far greater than from non-transparent components such as roofs or exterior walls. Therefore, transparent components such as windows are important for achieving adequate solar shading schemes.
- In addition, the effect of external shading, which shades solar radiation on the outside, is greater than that of internal shading, which shades solar radiation inside openings.
- For non-transparent components such as roofs and exterior walls, solar shading scheme is firstly to achieve insulation. In particular, roofs receive a large amount of solar radiation heat, with their surface temperatures in summer reaching 60 to 70 degrees. However, extra insulation can enhance solar shading effect. Secondly, methods should be considered such as using materials with high solar reflectance.

Fig. b  
Comparison of the solar shading performance of windows, roofs and exterior walls

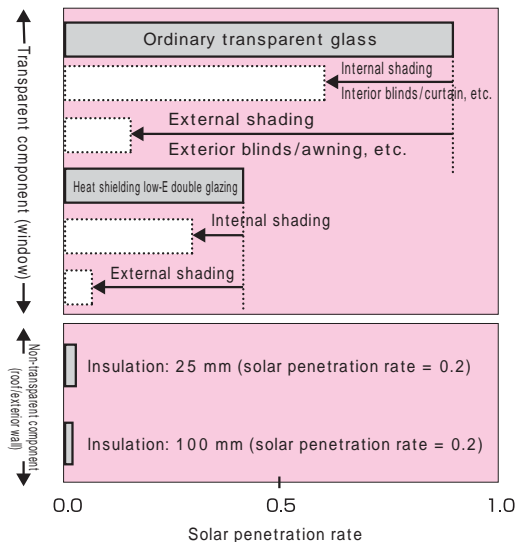

Glossary: Solar penetration rate  
The solar penetration rate is the proportion of heat that enters a room relative to the amount of incident solar radiation heat, and is also known as the solar heat gain coefficient. As this value decreases, the solar shading performance increases.

# 4

## 4.3.2 Energy Conservation Target Levels for Solar Shading Schemes

### 1. Definition of target levels

- Energy conservation target levels for solar shading schemes have been set at levels 1-3 as below and indicate the reduction rate of energy consumed by cooling systems (Table 1).
- The cooling energy reduction rate can vary even at the same level depending on which direction the main opening surface faces. Select the main opening surface and confirm which direction it faces out of south, southeast or southwest, or east or west. If it faces an in-between direction, select the closest direction.
- Among openings facing each direction (we are referring to windows here), the main opening surface must have a significantly larger opening area than the other directions. Please use the following conditions as references when selecting the main opening surface (one of the following must be met).
  - a. The percentage of opening area facing the direction concerned compared to the total area of a building is about 15% or higher.
  - b. The opening area facing the direction concerned is three times larger than opening areas facing the other directions.
- As for the cooling energy reduction rate, the state at level 0 where solar shading measures are not particularly implemented is used as a reference in the case of main opening surface facing the south. When the main opening surface faces southeast or southwest, or east or west, special attention is required as cooling energy increases at level 0.

Table 1 Target levels for solar shading schemes and energy saving effects

Target level	Direction of main opening surface		
	South	Southeast or southwest	East or west
Level 0	No cooling energy reduction (standard conditions)	30% cooling energy increase rate	10% cooling energy increase rate
Level 1	15% cooling energy reduction rate	20% cooling energy reduction rate	20% cooling energy reduction rate
Level 2	30% cooling energy reduction rate	25% cooling energy reduction rate	25% cooling energy reduction rate
Level 3	45% cooling energy reduction rate	35% cooling energy reduction rate	35% cooling energy reduction rate

- In the case of partial intermittent cooling, the standard cooling energy consumption as of 2000 was 5.7 GJ (approximately 8% of overall energy consumption) (See Section 6.1 on p.339).
- Several components such as openings, roofs and exterior walls are related to solar shading. In this document, of these components, the focus is placed on “solar shading methods for openings” where cooling energy reduction effects are confirmed through trial calculation. For each target level, values of “solar penetration rate at openings” obtained by implementing solar shading methods at openings are used as guidelines.

### 2. How to achieve target levels

#### 1) Target levels and solar penetration rate at openings

- The target level for energy conservation through solar shading can be achieved by implementing measures that meet standard values of solar penetration rate at openings (Table 2).
- Solar penetration rate indicates the ratio of heat that flows into a building out of incoming solar radiation heat. It is also called solar heat gain coefficient. The smaller it is, the higher solar shading performance is.
- The standard value of solar penetration rate at openings varies depending on the directions of openings. The amount of heat gain at an opening facing north (within the range of true north  $\pm 30^\circ$ ) is smaller than that at openings facing other directions (See Fig. a on p.189). Therefore, the necessity of solar shading schemes becomes relatively smaller while the standard value of solar penetration rate becomes greater than those of openings facing other directions.
- In order to achieve target levels, be aware that it is necessary to implement solar shading schemes which correspond to standard solar penetration rates for openings facing true north  $\pm 30^\circ$  as well as other directions (true south  $\pm 150^\circ$ ).
- Solar penetration rates at openings are set in accordance with the existing energy conservation standard. Level 1 conforms to the 1992 energy conservation standard and level 2 conforms to the 1999 energy conservation standard. Level 3 is based on performance levels superior to them.
- Fig. 1 shows the differences between these three levels.

Table 2 Target levels of solar shading schemes and how to achieve them

Target level	Standard values of solar penetration rates at openings		Energy conservation standard to conform to
	True north $\pm 30^\circ$	Range other than the direction listed in the left column	
Level 0	Approx. 0.79	Approx. 0.79	-
Level 1	0.79 or below	0.60 or below	1992 energy conservation standard
Level 2	0.55 or below	0.45 or below	1999 energy conservation standard
Level 3	0.55 or below	0.30 or below	-

Fig. 1 Standard values of solar penetration rate at openings by direction

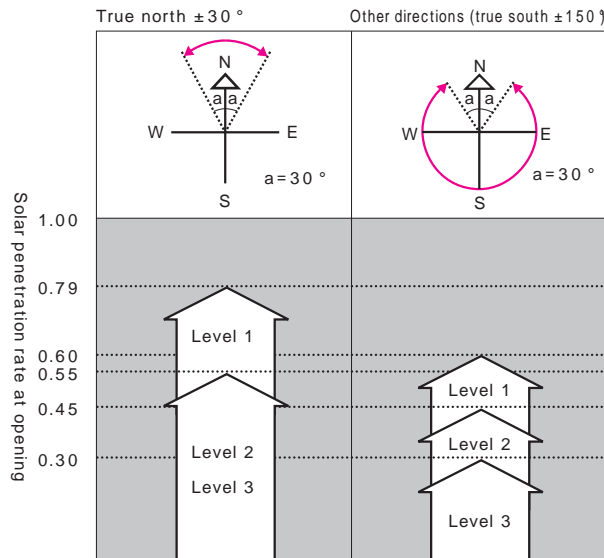

## 2) Methods for calculating solar penetration rates at openings

- Solar penetration rates at openings are determined by how thoroughly measures are implemented for solar shading components, such as glazing, curtains and blinds, as well as for overhangs/eaves (hereinafter referred to as “overhangs”). When these factors are combined, the solar penetration rate is obtained by using the following simple calculation method.

Solar penetration rate at opening = Solar penetration rate of glazing  $\times$  shading coefficient of solar shading components  $\times$  shading coefficient of overhangs

- Solar penetration rate of glazing, shading coefficient of solar shading components, and shading coefficient of overhangs each have determined values according to glazing specifications, component types, and whether overhangs exist or which directions they face, respectively (See Comment on p.193). Substitute relevant values to the formula above to obtain solar penetration rate at opening.
- The performance improvement rate of each solar shading component, such as glazing and blinds, will appear as the difference in solar shading performance in cases where they are combined.
- When there are no overhangs, etc., or when conditions in Fig. 2 are not met even if there are overhangs, etc., the shading coefficient is 1, which means that a decrease in solar penetration rate through overhangs, etc. cannot be expected. It is necessary to adjust the projection of overhangs and eaves according to the height of openings.
- Table 3 shows the result of calculating the solar penetration rate of openings which combine glazing, solar shading components and

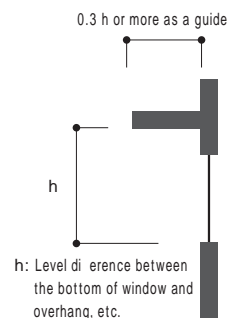

Fig. 2 Overhangs, etc. effective for solar shading

# 4

## Chapter 4 Heat Control Technology of Building Envelopes (Elemental Technology Application Method 2)

**Glossary: Low-E double glazing**  
The glass coated with special metal film (low-emissivity: low-E film) is generally known as low-E glazing. A structure wherein this low-E double glazing is used for the outer pane of double glazing (a special metal film faces the air space) is called "heat shielding low-E double glazing", since it offers high solar shading performance. Furthermore, a structure wherein low-E glazing is used for the inner pane is called "insulating low-E double glazing", since it places a higher value on insulation performance than heat shielding performance.

**Glossary: Heat shielding double glazing**  
Double glazing which uses glass with high solar shading performance for the outer pane is called heat shielding double glazing. Heat reflecting glazing or heat absorbing glass may be used for the outer pane of double glazing.

overhangs.

- The differences in color in the table indicate the correspondence relationship with levels.

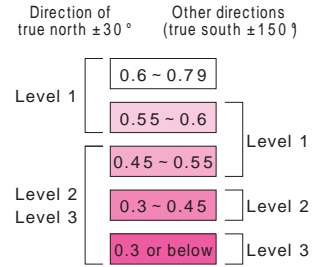

Table 3 Solar penetration rate obtained through the combination of glazing, solar shading components and overhangs, etc.  
(1) Without overhangs, etc.

Glazing specifications	Solar shading component type				
	None	Sheer curtain	Internal blinds	Paper sliding door	External blinds
Regular single glazing	0.88	0.56	0.46	0.38	0.19
Regular double glazing	0.79	0.52	0.44	0.37	0.17
Regular triple glazing	0.71	0.50	0.44	0.38	0.16
Insulating low-E double glazing (12 mm air space)	0.63	0.48	0.43	0.37	0.15
Insulating low-E double glazing (6 mm air space)	0.62	0.47	0.43	0.37	0.15
Heat shielding low-E double glazing (12 mm air space)	0.42	0.32	0.29	0.26	0.11
Heat shielding low-E double glazing (6 mm air space)	0.43	0.33	0.30	0.26	0.11
Heat shielding double glazing (2 types of heat reflecting glazing, 6 mm air space)	0.39	0.31	0.28	0.25	0.10
Heat shielding double glazing (3 types of heat reflecting glazing, 6 mm air space)	0.28	0.23	0.21	0.19	0.08
Heat shielding double glazing (Heat absorbing glazing, 6 mm air space)	0.57	0.41	0.36	0.31	0.13
2 types of heat reflecting single glazing	0.48	0.38	0.34	0.31	0.12
3 types of heat reflecting single glazing	0.35	0.31	0.28	0.25	0.10
Heat absorbing single glazing	0.68	0.47	0.41	0.35	0.15

(2) With overhangs, etc./Directions other than true south  $\pm 30^\circ$

Glazing specifications	Solar shading component type				
	None	Sheer curtain	Internal blinds	Paper sliding door	External blinds
Regular single glazing	0.62	0.39	0.32	0.27	0.13
Regular double glazing	0.55	0.36	0.31	0.26	0.12
Regular triple glazing	0.50	0.35	0.31	0.27	0.11
Insulating low-E double glazing (12 mm air space)	0.44	0.34	0.30	0.26	0.11
Insulating low-E double glazing (6 mm air space)	0.43	0.33	0.30	0.26	0.11
Heat shielding low-E double glazing (12 mm air space)	0.29	0.23	0.20	0.18	0.07
Heat shielding low-E double glazing (6 mm air space)	0.30	0.23	0.21	0.18	0.08
Heat shielding double glazing (2 types of heat reflecting glazing, 6 mm air space)	0.27	0.21	0.19	0.18	0.07
Heat shielding double glazing (3 types of heat reflecting glazing, 6 mm air space)	0.19	0.16	0.15	0.13	0.06
Heat shielding double glazing (Heat absorbing glazing, 6 mm air space)	0.40	0.29	0.25	0.22	0.09
2 types of heat reflecting single glazing	0.34	0.27	0.24	0.22	0.08
3 types of heat reflecting single glazing	0.24	0.21	0.20	0.18	0.07
Heat absorbing single glazing	0.47	0.33	0.28	0.25	0.11

(3) With overhangs, etc. / Directions of true south  $\pm 30^\circ$

Glazing specifications	Solar shading component type				
	None	Sheer curtain	Internal blinds	Paper sliding door	External blinds
Regular single glazing	0.44	0.28	0.23	0.19	0.09
Regular double glazing	0.39	0.26	0.22	0.19	0.09
Regular triple glazing	0.36	0.25	0.22	0.19	0.08
Insulating low-E double glazing (12 mm air space)	0.32	0.24	0.22	0.19	0.08
Insulating low-E double glazing (6 mm air space)	0.31	0.24	0.22	0.19	0.08
Heat shielding low-E double glazing (12 mm air space)	0.21	0.16	0.14	0.13	0.05
Heat shielding low-E double glazing (6 mm air space)	0.21	0.17	0.15	0.13	0.06
Heat shielding double glazing (2 types of heat reflecting glazing, 6 mm air space)	0.20	0.15	0.14	0.13	0.05
Heat shielding double glazing (3 types of heat reflecting glazing, 6 mm air space)	0.14	0.11	0.10	0.10	0.04
Heat shielding double glazing (Heat absorbing glazing, 6 mm air space)	0.29	0.20	0.18	0.16	0.07
2 types of heat reflecting single glazing	0.24	0.19	0.17	0.15	0.06
3 types of heat reflecting single glazing	0.17	0.15	0.14	0.13	0.05
Heat absorbing single glazing	0.34	0.24	0.20	0.18	0.08

### Comment Simple calculation method for solar penetration rate of opening

The solar penetration rate of each opening of housing can be calculated, if (1) glazing type, (2) solar shading component and (3) overhangs, etc. (their directions) are determined, based on the formula (1)  $\times$  (2)  $\times$  (3) shown below. However, as for the comprehensive

solar penetration rate of an opening, more detailed calculation may be necessary, strictly speaking, as slightly complicated mechanisms such as the interaction between glazing and solar shading components are involved.

Fig. Simple calculation data on solar penetration rate of opening

(1) Solar penetration rate of glazing

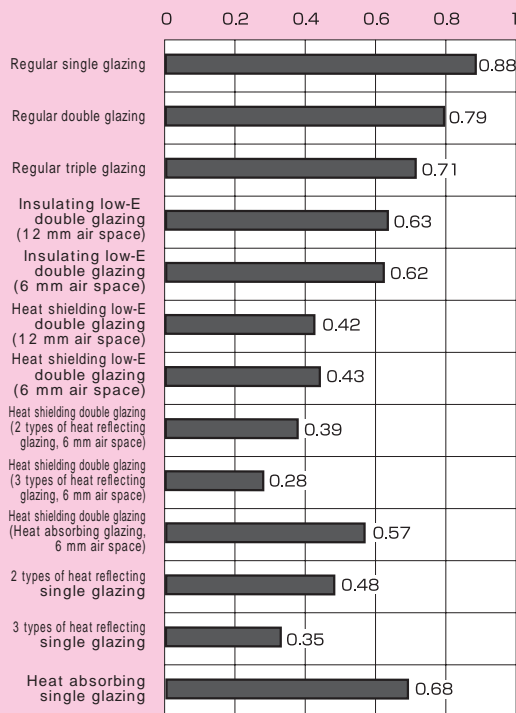

\* With regard to the type of glazing not listed above, use the numerical values provided by manufacturers.

(2) Shading coefficient of solar shading component

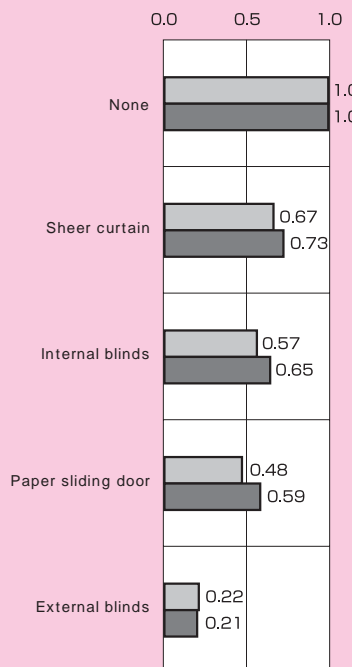

Glazing specifications 1: Regular single glazing  
Regular double glazing  
Glazing specifications 2: Glazing listed in " (1) Solar penetration rate of glazing " other than the types above

\* With regard to solar shading components not listed above, use the numerical values provided by manufacturers.

(3) Shading coefficient of overhangs, etc.

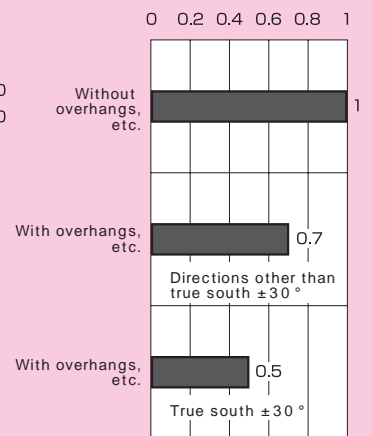

\* See Fig. 2 on p.191 for the conditions of overhangs, etc. effective for solar shading.

# 4

## Comment Solar penetration rate measurement results

Recently, the measurement of an opening's comprehensive solar penetration rate has become possible thanks to the use of artificial

sunshine. Fig a shows part of the measurement results (case of metal frame with thermal break).

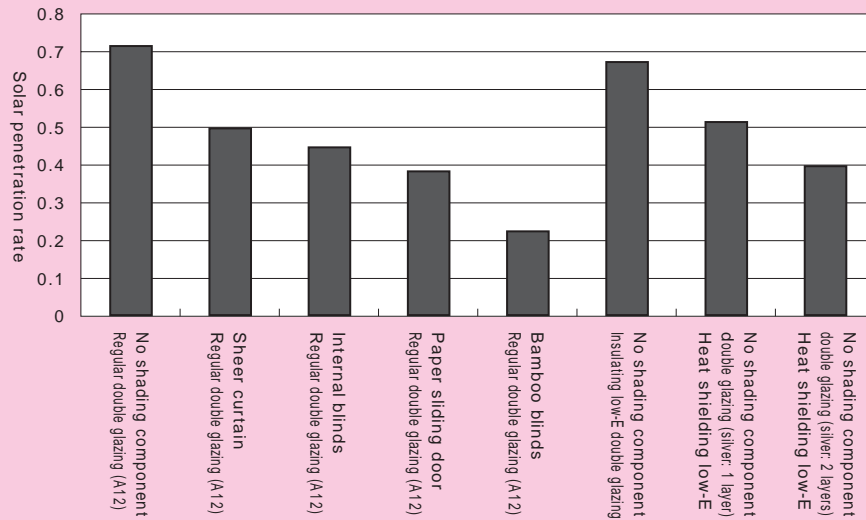

Fig a Measurement results of solar penetration rate of opening

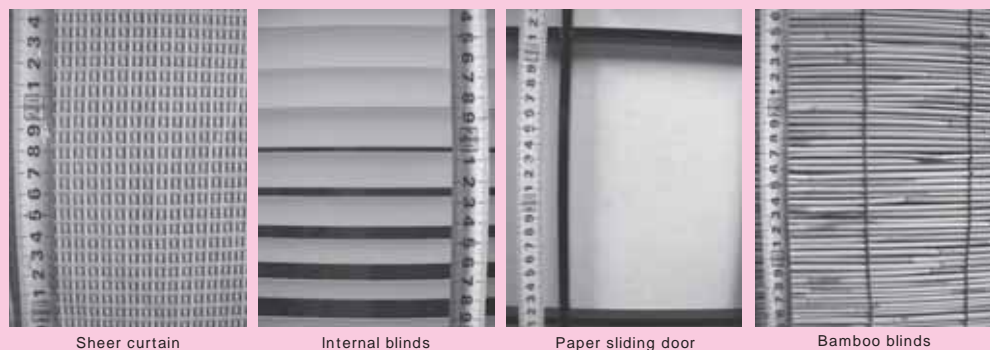

Fig b Solar shading components used for measurement

### 3) Handling roofs, exterior walls, etc.

- As for non-transparent areas of roofs and exterior walls, if insulation described in “4.1 Insulated Building Envelope Planning for Zone V” is applied, solar penetration rates are much lower compared to transparent areas. Therefore, they are not handled as elements related to the achievement of target levels. However, since the size of roofs and exterior walls is large and their influence on cooling load is not small, their handling methods are explained in “4.3.4 Solar shading methods”.



### 4.3.3 Steps for Examining Solar Shading Technology and Setting Target Levels

#### 1. Steps for examining solar shading technology

##### Step 1 Confirming the site condition / Setting target levels

- Confirm solar radiation which buildings receive according to the site condition.
- Examine opening layout planning that takes solar radiation into account while considering conditions such as views. Then, set target levels for solar shading schemes.

##### Step 2: Examining solar shading methods for openings Method 1

- 1) Selecting windows effective in solar shading
- 2) Solar shading for openings using solar shading components
- 3) Solar shading for openings using overhangs, etc.

##### Step 3: Examining solar shading methods for openings Method 2

- 1) Using roofing with high solar reflectance
- 2) Solar shading through attic ventilation (in the case of ceiling insulation)
- 3) Solar shading through roof ventilation control (in the case of roof insulation)

##### Step 4: Examining solar shading methods for exterior walls Method 3

- 1) Using exterior wall materials with high solar reflectance
- 2) Solar shading through exterior wall ventilation control

##### Step 5: Examining solar shading methods for others Method 4

- 1) Prevention of reflected heat
- 2) Solar shading with garden trees

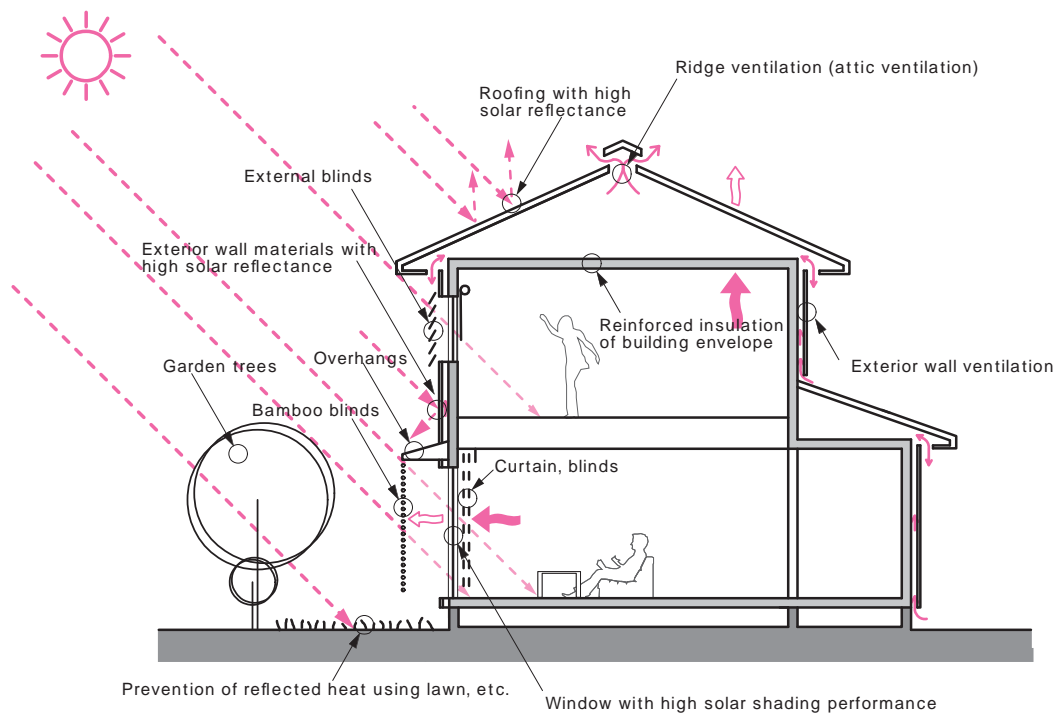

Fig. 3 Overview image of solar shading methods

# 4

Chapter 4  
Heat Control Technology of  
Building Envelopes  
(Elemental Technology  
Application Method 2)

## 2. Confirming surrounding conditions of building and setting target levels

By confirming the surrounding conditions of the building and planning layout of openings to take solar radiation into account, set the target levels of solar shading for openings.

### 1) Confirmation of surrounding conditions of building

- The necessity of solar shading varies depending on the level of solar shading which a building receives in summer and in-between seasons. Therefore, it is necessary to confirm the surrounding conditions of the building and predict the level of solar radiation which the building receives.
- Solar radiation level may be lower in the case of sites where hours of having shade are long due to surrounding buildings or the case of small sites where space between neighboring buildings is small such as small sites in cities. In these cases, the necessity for solar shading schemes is thought to be lower.

### 2) Layout planning for openings which takes solar radiation into account

- In order to achieve as much solar shading as possible in summer and receive more solar radiation in winter, it is important that the direction of openings is southerly.
- If openings have to face east and west when taking into consideration views or their relationship with roads and neighboring houses, it is essential to use solar shading components.
- When openings are created facing the southerly direction (true south  $\pm 30^\circ$ ), great solar shading effects through overhangs, etc. can be expected (See Fig. (3) of Comment on p.193).

### 4.3.4. Solar shading methods

#### Method 1: Solar shading methods for openings

- When solar shading schemes are not implemented for openings, temperature inside a building will rise in summer and in-between seasons, leading to a loss of comfort as well as a significant increase in cooling energy.
- Fig. 4 shows the comparison of window surface temperature between a window with external blinds and a window with internal blinds. When solar shading is done inside the building, such as with internal blinds, it is clear that the window surface receiving solar radiation increases in temperature like a large panel heater.
- Solar shading methods for openings can be divided into types shown in Table 4, and it is necessary to select an appropriate method according to conditions.

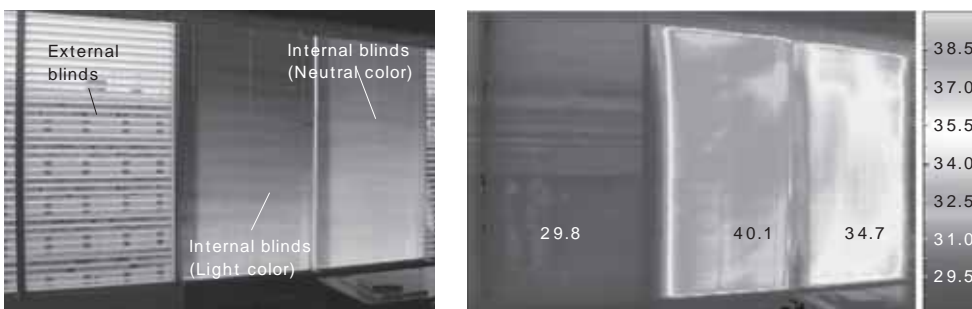

Fig. 4 Comparison of window surface temperature with the use of blinds

Table 4 Solar shading methods for openings and effects

Solar shading methods for openings	Outline	Effect
1) Selecting windows effective in solar shading	Solar shading method through the use of sashes and glass with high heat shielding performance	Medium
2) Solar shading for openings using solar shading components	External solar shading components	Great
	Internal solar shading components	Small
3) Solar shading for openings using overhangs, etc.	Method using overhangs, which blocks off solar radiation entering through openings. The solar shading effect varies depending on the direction of overhangs and the measurement of their projection.	Great when attached to the south side

#### 1. Selecting windows effective in solar shading

- This is a solar shading method using windows themselves, and its solar shading effect varies depending on the solar reflectance and heat transmission coefficient of glazing and frame.
- Openings are the components that can be a weak point in terms of insulation performance. It is necessary to select proper windows by considering insulated building envelope planning in addition to the perspective of solar shading.
- Windows with proper specifications should be selected according to the type of glazing as well as the materials and size of frame.

The colored version of Fig. 4 is shown in Appendix 2 on p.391.

Solar shading methods for Zone V 4.3

Conditions for inside and outside boundaries  
 Temperature: Outside 30°C  
 Inside 25°C  
 Solar radiation rate: 500 W/m<sup>2</sup>  
 Surface heat transfer coefficient:  
 Outside 23W/m<sup>2</sup>·K  
 Inside 9W/m<sup>2</sup>·K

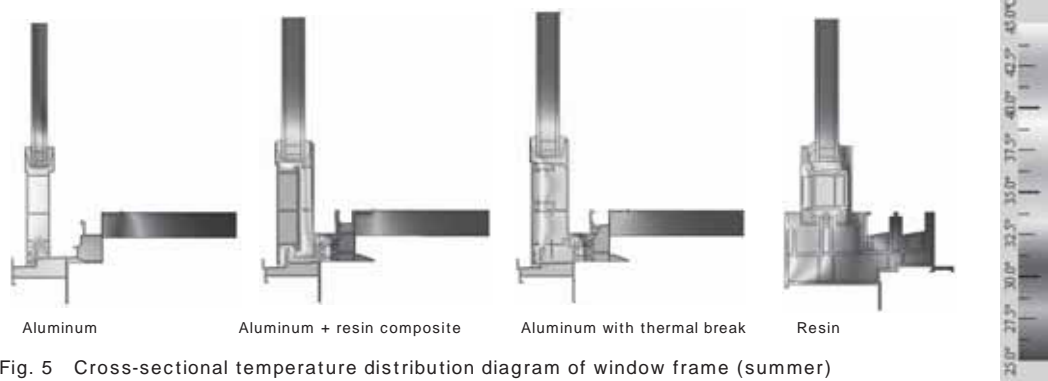

The colored version of Fig. 5 is shown in Appendix 2 on p.391.

Fig. 5 Cross-sectional temperature distribution diagram of window frame (summer)

### 1) Glazing types and solar shading effects

- In general, there are single glazing, double glazing, insulating low-E double glazing, heat shielding low-E double glazing, double glazing with built-in blinds and other types of glazing (Fig. 6, Fig. 7). Their characteristics are listed in Table 5.

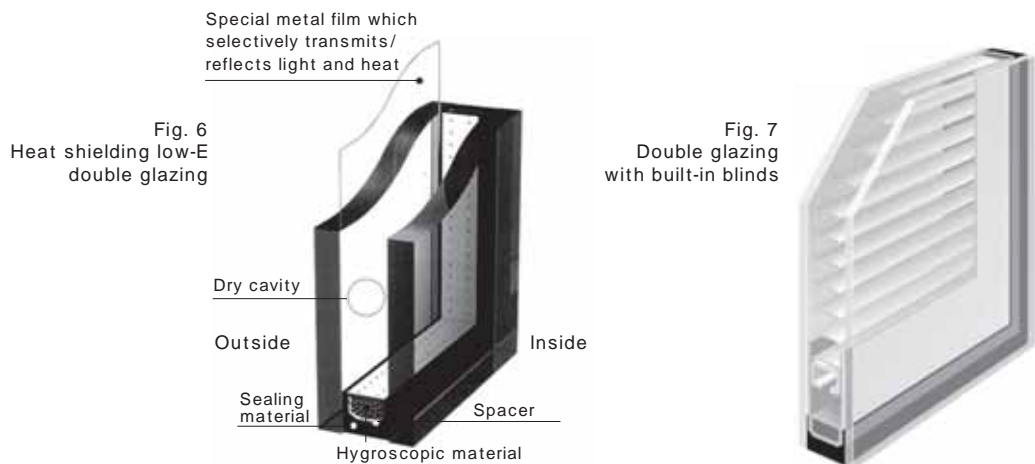

Table 5 Glazing types and characteristics

Glazing type	Characteristics	Effect
Single glazing	The most common transparent, flat pane glazing which transmits most solar radiation	Small
Regular double glazing	This glazing has enhanced insulation performance by sealing dry air into the space between two panes of glazing but transmits most solar radiation	Small
Insulating low-E double glazing	The glazing on the inner pane of this double glazing is coated with special metal low-E film which offers superior insulation performance and moisturizing effects, providing a solar shading effect to some extent	Small - medium
Heat shielding low-E double glazing	The glazing on the outer pane of this double glazing is coated with special metal low-E film which offers superior heat shielding and insulation performance, providing a solar shading effect	Medium
Double glazing with built-in blinds	Built-in blinds are in the cavity of this double glazing. In addition to a superior insulation effect, it provides the effect of controlling light by closing and opening the blinds, being effective in solar shading.	Medium - Great

### 2) Frame types and solar shading effects

- In general, there are sashes made of metal, metal with thermal break, metal and resin combined, resin, wood, and wood covered with metal or resin. Their characteristics are listed in Table 6.

Table 6 Frame types and characteristics

Frame type	Characteristics	Effect
Metal (aluminum)	Thermal conductivity is great, so this frame conducts absorbed solar heat into the room	Small
Metal with thermal break	Aluminum component with great thermal conductivity that is thermally separated into inner and outer panes by using resin materials so that heat cannot be conducted easily	Medium
Metal and resin (wood) combined	So that heat cannot be conducted easily, this frame uses highly durable aluminum for the outer pane and resin and wood, which make it difficult for heat to be conducted, for the inner pane	Medium
Resin, wood	Thermal conductivity is low, so this frame makes it most difficult for absorbed solar heat to be conducted into the room	Great

## 2. Solar shading for openings using solar shading components

- This method is designed to block solar radiation which tries to enter the building through openings by setting components effective in solar shading, such as blinds, louvers and screens, on the outside or inside of windows (Fig. 8).
- By using mobile solar shading components, it is possible to make adjustments, such as removing them, according to changes of season, time and weather as well as life-related demands such as views and ventilation.
- It is important to select components with appropriate specifications and mechanisms while taking cross ventilation utilization, daylight utilization and housing design into consideration.
- Solar shading components are divided into external and internal components. When internal solar shading components are used, most of the heat passing through the windows and hitting the surface of the solar shading components radiates into the room. Therefore, they are not as effective as external solar shading components (Fig. 9).

\* From a standpoint of daylight utilization, solar shading components are considered as devices with a sun control function. With regard to this, refer to p.074 and p.075.

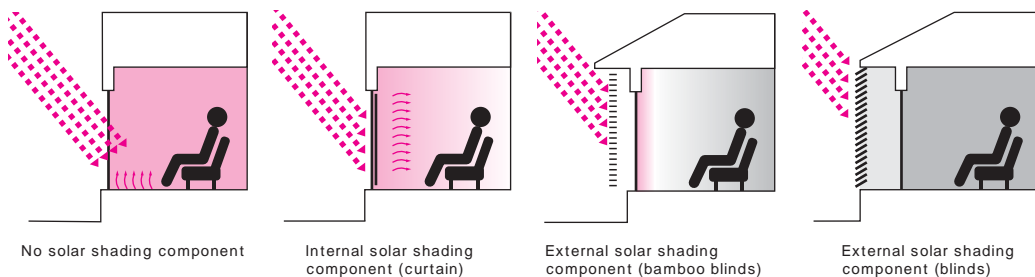

Fig. 8 Difference in effect depending on the existence and location of solar shading components for openings

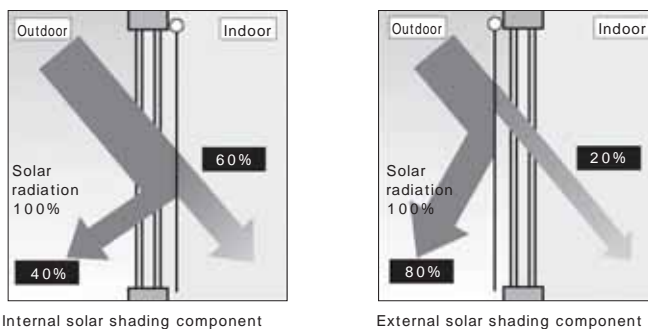

Fig. 9 Effect based on location of solar shading components (image)

### 1) External solar shading component planning

- External solar shading components include blinds, louvers, awnings, bamboo blinds and screens.
- It is necessary to select external solar shading components which are user-friendly and do not easily cause flapping or noise due to wind. Moreover, it is necessary to set them up at a safe, trouble-free place by taking into consideration the wind direction and velocity of the region.
- Table 7 shows the characteristics of each component (Fig. 10-14).

Table 7 Types and characteristics of external solar shading components

External solar shading component	Characteristics	Effect
Screen	This component helps regulate solar radiation and visibility from outside, but is vulnerable to wind	Medium - Great
Bamboo blinds	Reasonable but inferior to other shading components in terms of storage and durability	Medium - Great
Awning	Offers a good view as it does not face an opening directly	Medium - Great
Blind shutters	Highly functional component with the functions of blinds and shutters	Great
Blinds	Offers highly flexible regulation of solar radiation and visibility from outside, but is vulnerable to wind	Great
Louver	Fixed type without any vertical movement although its slats rotate	Great

# 4

## Chapter 4 Heat Control Technology of Building Envelopes (Elemental Technology Application Method 2)

### Note

A considerable amount of solar radiation enters a room through skylights set up on the roof even if it faces the north. Since there are few accessories for skylights which are effective in blocking solar radiation, it is important to keep this in mind.

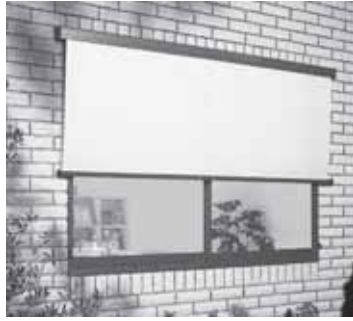

Fig. 10 Screen



Fig. 11 Bamboo blinds



Fig. 12 Awning



Fig. 13 Blind shutters



Fig. 14 Louver

### 2) Internal solar shading component planning

- Internal solar shading components include blinds, paper sliding doors, roller blinds and sheer curtains.
- Table 8 shows the characteristics of each component (Fig. 15, Fig. 16).

Table 8 Types and characteristics of internal solar shading components

Internal solar shading component	Characteristics	Effect
Sheer curtains	Helps regulate solar radiation and visibility from outside, but the solar shading effect varies depending on the color as well as how coarse the texture is	Small
Roller blinds	Helps regulate solar radiation and visibility from outside, but the solar shading effect varies depending on the color	Small - Medium
Paper sliding doors	Helps regulate solar radiation and visibility from outside, but the solar shading effect varies depending on the color	Medium
Blinds	Enables highly flexible regulation of solar radiation and visibility from outside, but the solar shading effect varies depending on the color	Medium



Fig. 15  
Paper sliding doors



Fig. 16 Wooden blinds

### 3. Solar shading for openings using overhangs, etc.

- This method is designed to block off solar radiation, which enters a building through openings, by using eaves attached to roofs and lean-to roofs as well as small overhangs, etc (Fig. 17). The solar shading effect in summer varies depending on the direction and the projection of overhangs, etc. Proper planning according to the direction is important.
- As for the east face and west face which receive solar radiation during hours when the solar altitude is low, not much of a solar shading effect through horizontal overhangs, etc. can be expected. On the other hand, as for openings on the south face, we can fully expect an effect from overhangs since the solar altitude is high (Fig. 18).



Fig. 17 Examples of solar shading using overhangs, etc.

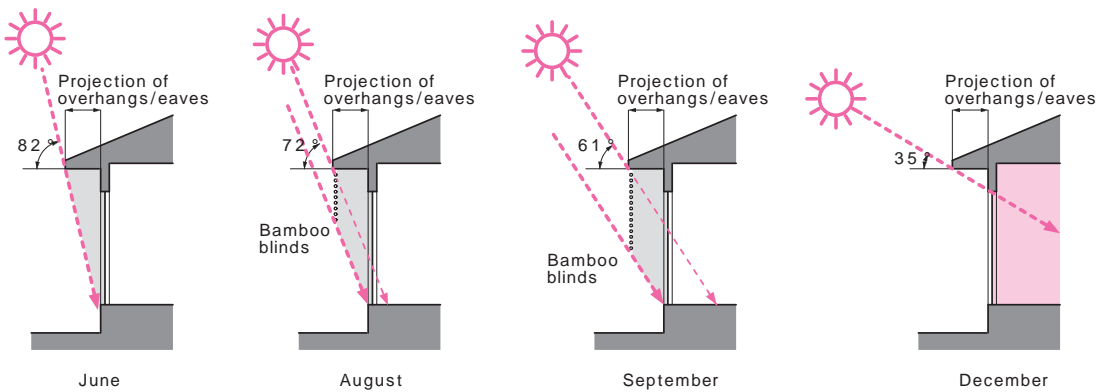

Fig. 18 Image of effects of overhangs, etc. (south)

**Note**  
By setting up overhangs, etc., solar shading effects for not only openings but also exterior walls can be expected. In addition, in winter, overhangs, etc. do not cause a significant loss in solar heat gain because the solar altitude is high.

Solar shading methods for Zone V 4.2

**Key point**

Method of planning overhangs, etc. which take directions into consideration

- With regard to openings facing south, it is thought that setting up overhangs with projection measuring one third or more in length of the vertical interval between the bottom of the window and the bottom of overhangs, etc. is effective in solar shading.
- With regard to openings facing east and west, solar shading using only overhangs, etc. is not so effective compared to the south. Therefore, combined use of other methods is thought to be effective, such as setting up solar shading components (Fig.).

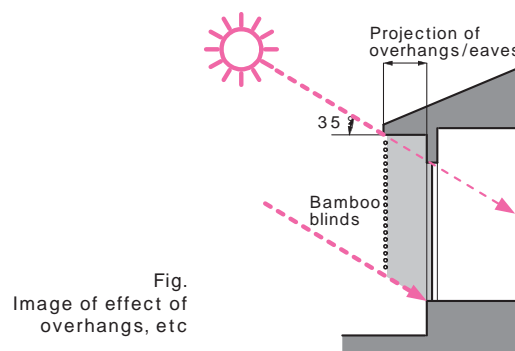

Fig. Image of effect of overhangs, etc

# 4

## Method 2: Solar shading method for roof

- Since roofs receive solar radiation for long periods, it is important to implement solar shading schemes in addition to insulation. It is necessary to implement measures which control the inflow of heat into the room through the roof as well as the inflow of heat and heat radiation through the ceiling.

### 1. Using roofing with high solar reflectance

- Solar shading effects can be enhanced by increasing the solar reflectance of the roof.
- The solar reflectance or absorption rate of a building material varies greatly depending on the color. In general, a material with a light color, rather than a dark color, or with luster, such as polished tiles, offers a higher solar reflectance, controlling temperature increase. Solar shading effects can be enhanced by using light-colored building materials for the outer surface of the building, such as roofing and exterior wall materials.
- When light-colored building materials cannot be used (for reasons of design or in order to avoid causing solar-radiation-related troubles to neighbors), there is a method using heat shielding paint, a method described in Method 3 (solar shading methods for exterior walls).

### 2. Solar shading through attic ventilation (in the case of ceiling insulation)

- In a house for which ceiling insulation is used, ensuring a large amount of attic ventilation is thought to be very effective in enhancing the solar shading effect of the roof.
- It is advisable for attic ventilation to be implemented five times or more per hour.
- See Fig. 19 to discuss attic ventilation methods and attic ventilation rate and make sure that air vent size is sufficient. However, the ratios of air vent size indicated in Fig. are the guidelines originally suggested for preventing condensation, and they indicate the minimum values. For solar shading, it is important to ensure a much larger air vent size. Fig. 20 shows an example of a house which puts emphasis on attic ventilation. The wall surface under the eave has many louvers.
- As for houses where double ceiling is not created for the second floor and the attic is exposed, heat exhaust through attic ventilation cannot be expected. Therefore, solar shading performance of the roof should be improved.

Air supply and exhaust through attic  
(1/300 or higher)

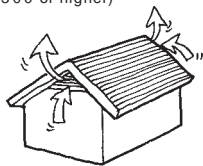

Air supply and exhaust through back of eaves  
(1/250 or higher)



\* Values in brackets show ratio of air vent size compared to ceiling size.

Air supply through back of eaves (1/900 or higher) + air exhaust through attic (1/900 or higher)

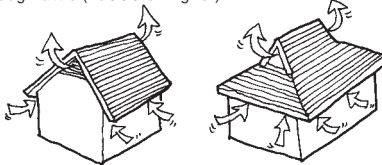

Air supply through back of eaves (1/900 or higher) + air exhaust through exhaust stack (1/1,600 or higher)

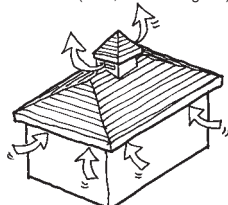

Fig. 19 Method of installing attic air vents



Fig. 20 Example of house which puts emphasis on attic ventilation



### 3. Solar shading through roof ventilation control (in the case of roof insulation)

- The temperature of the roof rises due to solar radiation, radiating heat into the building. In particular, it is very effective to install ventilated cavity for houses with roof insulation in order to control the amount of heat radiated from the roof to the inside of the building (Fig. 21).
- The size of a ventilated cavity should be as large as possible, and it is advisable to ensure at least 30 mm.
- Components for ventilating the ridge should be installed on the top of the roof.
- Attention is required when positioning furring strips in order to ensure a certain amount of ventilation.
- The opening of ventilated cavity should be as large as possible while the prevention of rain water infiltration is taken into consideration.

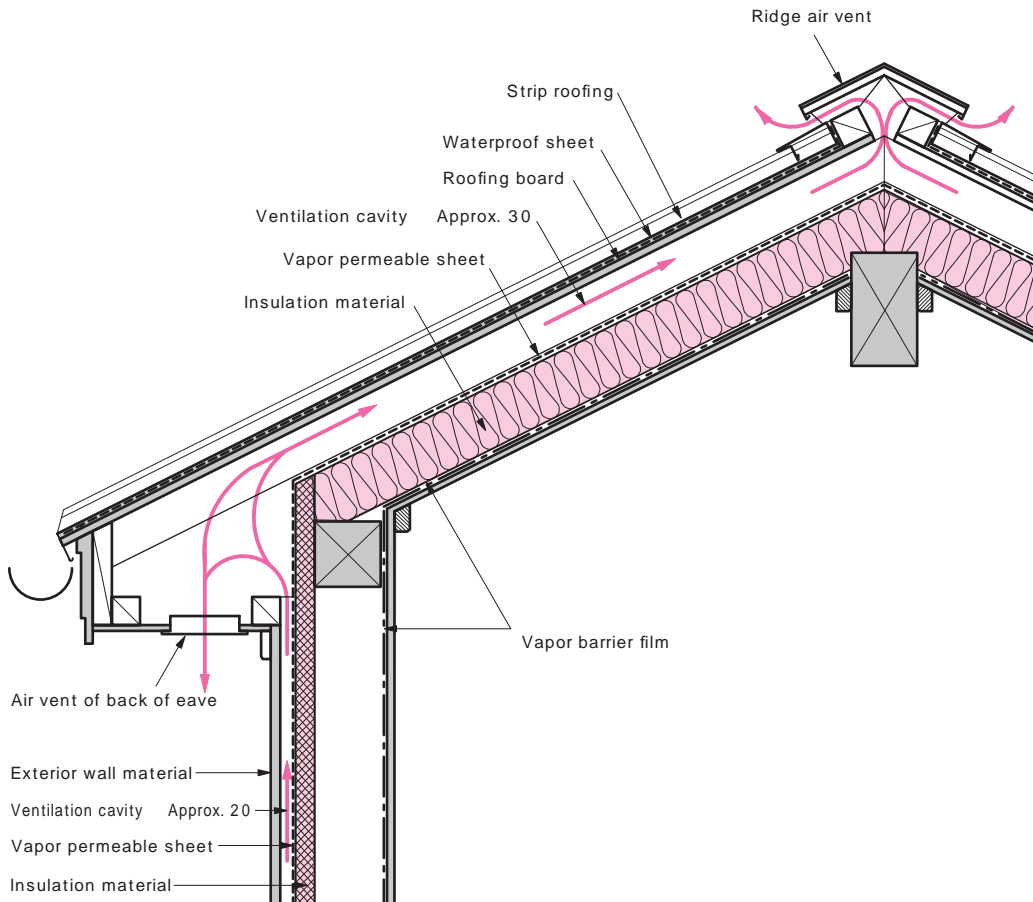

Fig. 21 Roof ventilation (in the case of roof insulation)

# 4

## Note

Recently, the term “insulation paint” is used sometimes. In general, it refers to a paint which effectively controls the amount of solar radiation absorption by increasing the reflectance of the surface. It should be called “heat shielding paint”. It is different from materials effective in increasing heat resistance such as normal insulation materials.

## Method 3: Solar shading method for exterior walls

- The foundation of solar shading schemes for exterior walls, as is the case for the roof, is to increase insulation performance. Try to improve the insulation performance of exterior walls by referring to “4.1 Insulated Building Envelope Planning for Zone V”, and at the same time, consider schemes for controlling the inflow of solar heat absorbed on the exterior wall surface into the inside of the building.

### 1. Using exterior wall materials with high solar reflectance

- The quantity of heat received varies depending on the color (solar reflectance) of exterior wall materials. It is desirable to use a color that is as close to white as possible for exterior wall materials.
- A heat shielding paint provides an enhanced reflectance in near-infrared regions, so this paint has a high solar reflectance accordingly (Fig. 22). Since a darker color provides a higher solar reflectance than a lighter one, this paint is used for enhancing the solar reflectance when a dark color is selected.

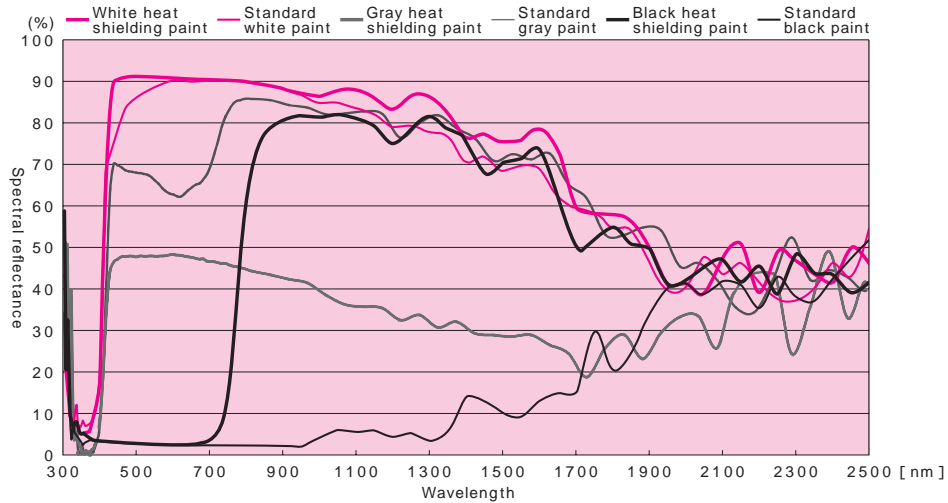

Fig. 22 Results of reflectance measurements using heat shielding paints

### 2. Solar shading through exterior wall ventilation control

- The temperature of exterior walls rises by receiving solar radiation, radiating heat into the inside of the building. In the case of a method using exterior wall material, it is effective to incorporate a ventilation cavity in order to control the quantity of heat radiated into the building through the exterior wall material (Fig. 23). A ventilation cavity is also effective in preventing rain water infiltration as well as releasing moisture accumulated inside the wall.
- It is desirable to ensure that the size of ventilation cavity is approximately 20 mm.
- The opening of a ventilated cavity should be as large as possible.
- Attention is required when positioning furring strips in order to ensure ventilation cavity.

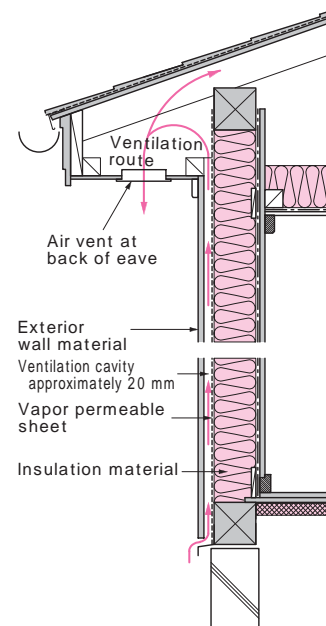

Fig. 23 Ventilation control of exterior wall

## Method 4: Other solar shading methods

### 1. Prevention of reflected heat

- It is possible for the inside of the building to receive heat through openings due to heat reflected from the surface of the earth, porch, balcony, and surrounding buildings' roofs and walls.
- In order to reduce heat which the inside of the building receives as much as possible, it is necessary to consider the materials and finish of surfaces reflecting heat.

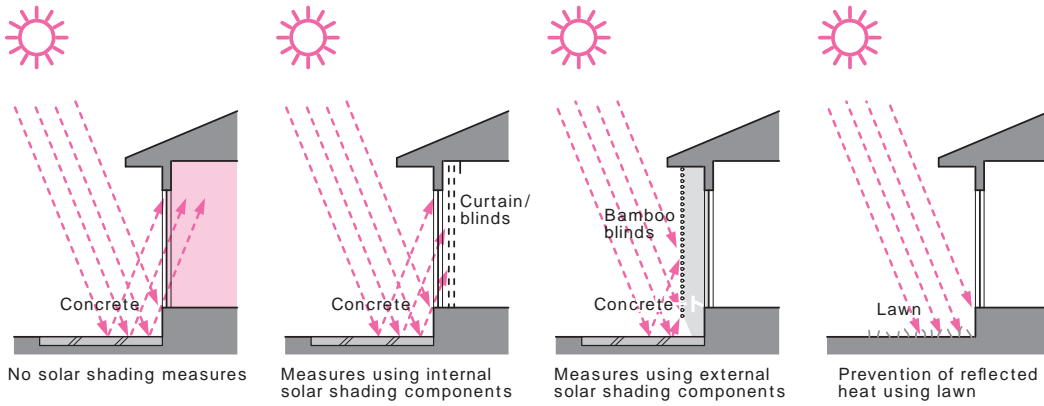

Fig. 24 Image of prevention of reflected heat

### 2. Solar shading with garden trees

- In a house with a garden, trees around the house can be expected to play an effective role in solar shading (Fig. 25).
- Deciduous trees block solar radiation in summer but do not block the sunlight much in winter because leaves fall. Therefore, they can be used for improving the comfort of the inside of the house (Fig. 26).



Fig. 25 Example of residential area where garden trees and green walls are used for solar shading

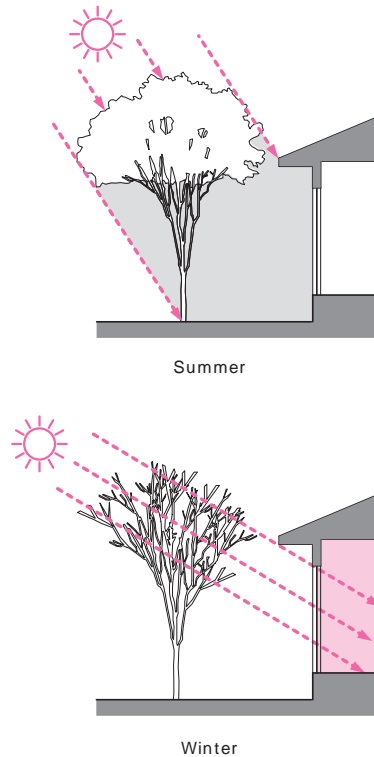

Fig. 26 Solar shading with garden trees

